



Made with passion in



EVOTECH

DEDICATO A CHI SA SCEGLIERE
THE RIGHT CHOICE

versione

9

EVOTECH

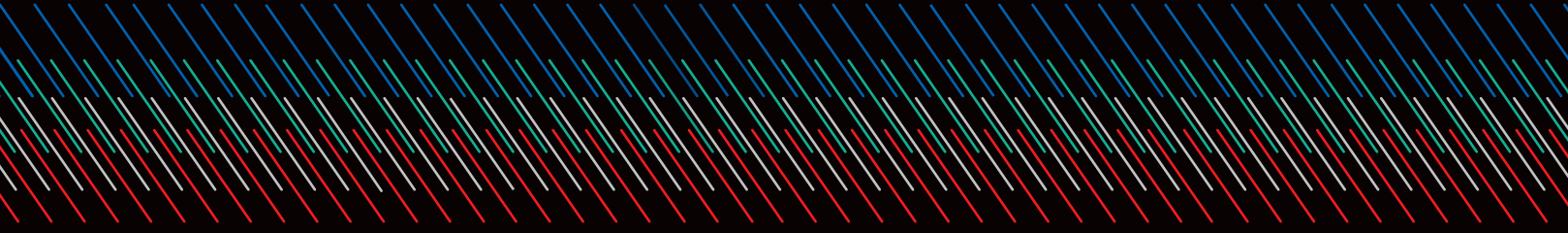

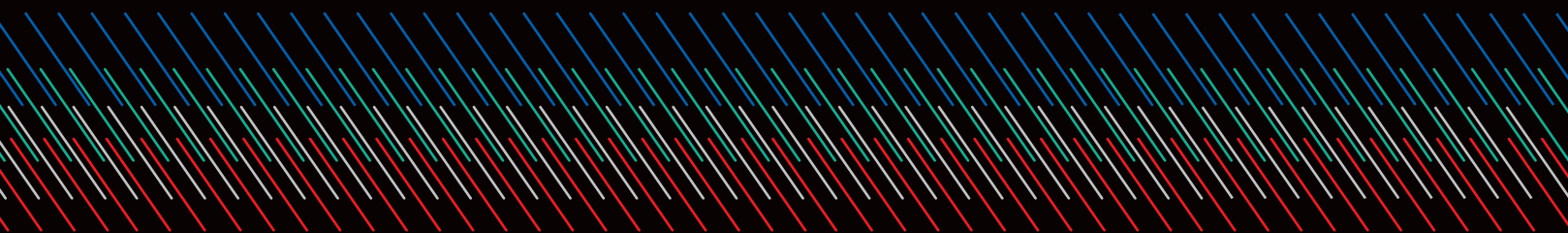

Il marchio EVOTECH rappresenta un'azienda giovane e dinamica che si realizza in un mix di tecnologia, innovazione e qualità. Grazie alla sinergia tra uno staff altamente specializzato e le migliori tecnologie presenti sul mercato, Evotech è in grado di sviluppare, realizzare e proporre sul mercato dei prodotti con un alto contenuto di stile e tecnologia, riassunti semplicemente nel significato stesso del marchio, EVOLUZIONE TECNOLOGICA.

L'azienda risulta prettamente rivolta a concentrare il maggior numero di attività produttive al suo interno per massimizzare la reattività nei confronti del mercato e rispondere nel più breve tempo possibile alle richieste dei clienti. Particolare attenzione viene nello sviluppo dei prodotti mantenendo alti i punti di forza riconosciuti dal mercato: funzionalità dei sistemi, semplicità di montaggio, design e stile unico, qualità in tutta la catena produttiva.

La ricerca prende ampio spazio all'interno dell'azienda per offrire al mercato delle soluzioni ricche di contenuti e utilità.

EVOTECH brand represents a young and dynamic company that works mixing technology, innovation and quality. Thanks to the synergy among a skilled staff and thanks also to the best technologies on the market, Evotech designs, realizes and offers you high quality products. The ability to combine all these elements can be simply translated in our brand core, TECHNOLOGICAL EVOLUTION. Evotech aims to have all the production steps inside the company in order to maximize and to face the market demand in short time. By paying a particular attention to products progress Evotech maintains the right approach with the market requirements: system functionality, simplicity in the assembling, an unique style, quality in all the processes. Finally Evotech research has an important role in the company in order to always offer the market the most rich and useful solutions.

AGENTE

FAX TEL

EVOTECH FAX +39 0461-782707 TEL +39 0461-780184

www.evotech-rc.it / e-mail: info@evotech-rc.it

.....

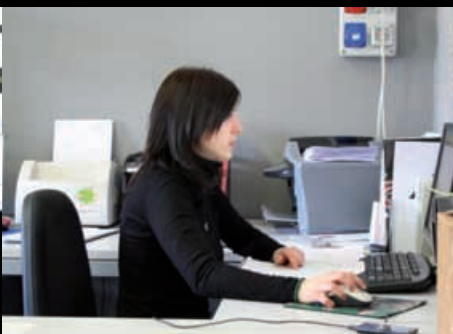
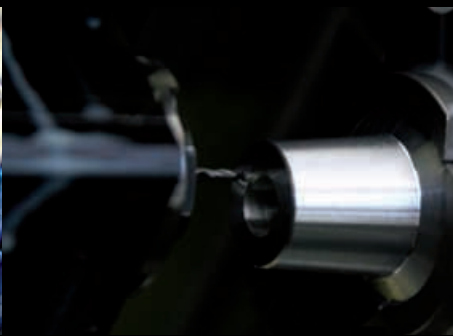
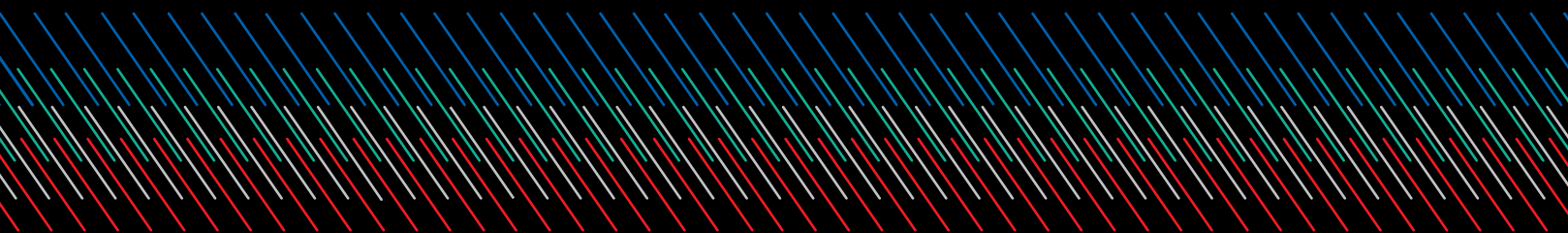

Biagio Calvaruso, responsabile commerciale
Marco Ongaro, responsabile officina
Ing. Matteo Tisi, progettista
Maurizio Osler, responsabile tecnico
Maria Battaglia, amministrazione
Gloria Zanghellini, export department

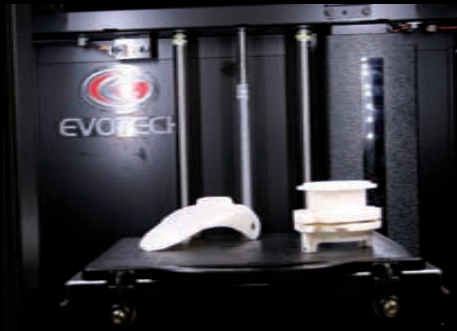
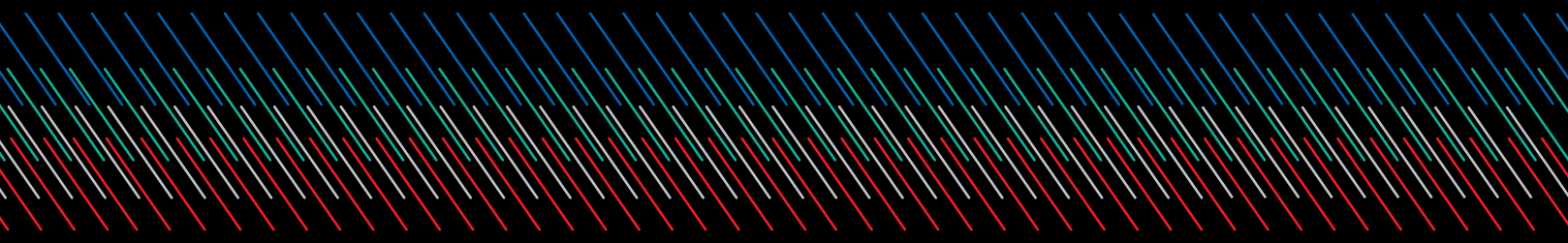

INDEX

PORTATARGA \ LICENCE PLATE HOLDER	01 - 05
TAMPONI PARATELAIO \ FRAME SLIDERS	06 - 13
TAPPI CINGHIA \ ALUMINIUM PLUGS	14
PROTEZIONE MOTORE \ ENGINE PROTECTOR	15
GEMS OF THE WIND	16
FINAL STORM	17 - 18
PADDOCK STANDS	19
BLOCCHETTI TENDICATENA \ AXIAL BLOCKS	20
THUNDERBOLTS	21 - 24
COVER PERNO RUOTA T-MAX \ WHEEL PIN COVER T-MAX	25
TAPPI OLIO \ OIL FILLER CAP	26
SERBATOIO LIQUIDO FRENO \ RESERVOIR TANK	27
TAPPI SERBATOIO \ FUEL CAP	28
TAPPO SERBATOIO A SGANCIO RAPIDO \ RAPID FUEL CAP	29 - 31
KIT VITI SERBATOIO \ FUEL CAP BOLTS KIT	32 - 33
KIT VITI CUPOLINO \ SCREEN BOLTS KIT	34 - 35
VITERIA IN ERGAL \ ERGAL BOLTS	36 - 40
COOL STRIPES	41
ACCESSORI RACING \ RACING ACCESSORIES	42 - 43
CONDIZIONI GENERALI DI VENDITA \ GENERAL SALE CONDITIONS	47 - 48

porta targa
license plate holder

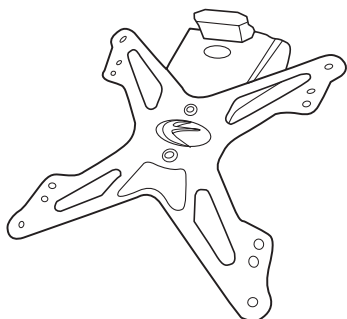

paddock stands

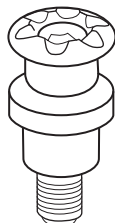

blocchetti tendicatena
axial blocks

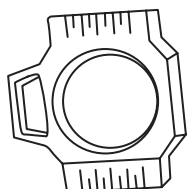

thunderbolt



tappi olio
oil filler cap

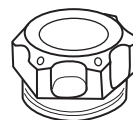

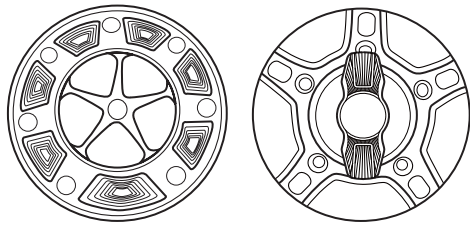

tappo serbatoio
fuel cap

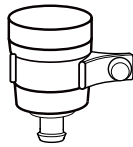

serbatoio liquido freno
reservoir tank

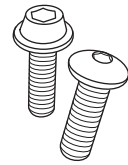

viteria in ergal
ergal bolts



adattatori frecce
indicators light adapters



gems of the wind

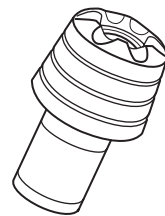

final storm

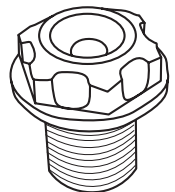

thunderbolt

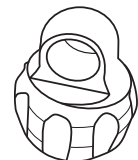

tappo cinghia
aluminium plug



aprilia

protezione motore
engine protector

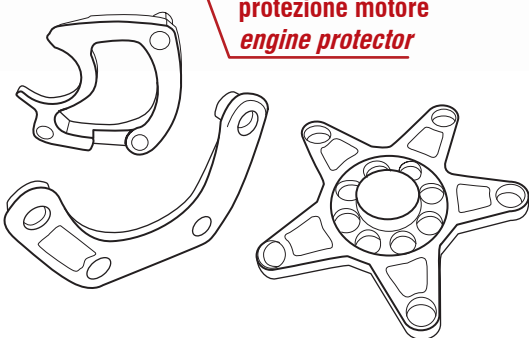

tamponi paratelaio
frame sliders

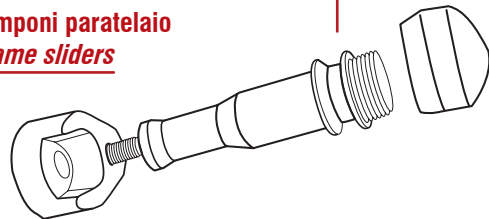

PORTATARGA LICENSE PLATE HOLDER

Prodotto dal design rivoluzionario, leggero, racing e regolabile. Pregiata placca di attacco targa in alluminio nero laccato, diversificata a seconda del paese. Robusto supporto in materiale tecnico con ANTI-TUNING SYSTEM per ridurre le fastidiose vibrazioni trasmesse dalla moto. Supporti per indicatori di direzione in alluminio con foro unico diametro 10mm. Staffe in alluminio diversificate a seconda del modello.

Opzionale:

- dispositivo illuminazione targa
- supporto per dispositivo catarifrangente
- supporti per indicatori di direzioni originali

Prodotto brevettato, Design registrato

Evotech new racing adjustable, extremely light and with a revolutionary design license plate holder. Black anodized, varnished aluminium support adjusted to each country. Solid support made of tecnopolymer material with ANTI-TUNING SYSTEM to reduce the continous irritating road vibrations. Our kits include the supports for the fixing of aftermarket indicators light with one single hole diameter 10mm. Each kit includes specific brackets made of aluminium diversified depending on the model.

Optional:

- lighting device for the license plate
- rear reflecting support
- supports for original indicators light

Patented product, Registered design

**GARANZIA PRODOTTO 5 ANNI
5 YEARS PRODUCT GUARANTEE**



Placca

- \ alluminio aeronautico ricavato dal pieno
machined from billet aluminium
- \ trattamento di ossidazione anodica nero
black anodization
- \ disponibilità misure per i principali paesi
specific size for each country
- \ orientamento in due posizioni
two interchangeable positions

Supporto

- \ materiale tecnopolimero antiurto
shockproof tecnopolymer material
- \ colorazione nera anti UV
black UV-resistant colour
- \ progettazione tramite analisi elementi finiti
FEM analysis
- \ testato su banco prova vibrazionale
tested product





Honda

PORTA TARGA LICENSE PLATE HOLDER

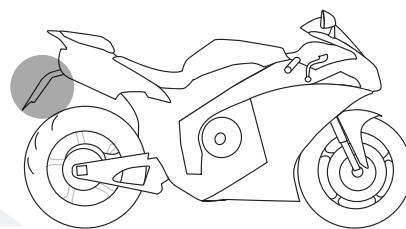

MARCA / BRAND	MODELLO / MODEL	ANNO / YEAR	CODICE / CODE	ANNO w/o tax
APRILIA	Tuono / RSV	'04 -'08	ESTR-1001	70,00
	Dorsoduro	'08 -'10	ESTR-1002	70,00
	RS 125	'08 -'10	ESTR-1004	70,00
	Shiver	'07 -'10	ESTR-1003	70,00
	RSV4 FACTORY/R	/	ESTR-1005	70,00
BMW	S1000 RR	'10	ESTR-1102	90,00
	K1300R	'10	ESTR-1101	110,00
DUCATI	999	'10	ESTR-0801	140,00
	1198/1098/848** ++	/	ESTR-0802	160,00
	HYPERMOTARD	'07 -'10	ESTR-0804	70,00
	Monster 696	/	ESTR-0805	105,00
	Monster 1100	/	ESTR-0806	105,00
	Streetfighter	/	ESTR-0807	75,00
HARLEY DAVIDSON	Sportster	/	ESTR-1201	95,00
HONDA	CBR 600 RR	'03 -'06	ESTR-0103	100,00
	CBR 1000 RR	'04 -'07	ESTR-0103	100,00
	CBR 1000 RR	'08 -'09	ESTR-0111	149,00
	CBR 1000 RR	'10	ESTR-0112	100,00
	CBR 600 RR ++ con faro a led s.d.	'07 -'10	ESTR-0108	190,00
	CB 1000 R	'08 -'10	ESTR-0110	140,00
KAWASAKI	Z 750 / Z 1000**	'07 -'10	ESTR-0406	85,00
	Z 1000	'07 -'09	ESTR-0406	85,00
	Z 1000	'10	ESTR-0411	70,00
	ZX6R ++ con faro a led	'07 -'08	ESTR-0405	130,00
	ZX6R	'09 -'10	ESTR-0407	70,00
	ZX 10 R**	'08 -'10	ESTR-0407	70,00
	ER-6N	'09 -'10	ESTR-0410	70,00
	Versys	'10	ESTR-0412	in costruzione
KTM	690 SMC / Enduro	/	ESTR-0902	120,00
	990 Supermoto / R / T	/	ESTR-0904	90,00
	690 Duke	'08 -'10	ESTR-0901	70,00
	1190 RC8	'08 -'10	ESTR-0903	70,00
	690 Supermoto / R	'07 -'10	ESTR-0901	70,00
MV AGUSTA	Brutale	< '10	ESTR-0501	70,00
	F4	'10 >	ESTR-0502	in costruzione
SUZUKI	GSX-R 600 / 750*	'06 -'07	ESTR-0306	70,00
	GSX-R 600 / 750*	'08 -'10	ESTR-0309	70,00
	GSX-R 1000*	'05 -'08	ESTR-0305	70,00
	GSX-R 1000*	'09 -'10	ESTR-0312	70,00
	SV-650/S	'03 -'08	ESTR-0311	70,00
	Gladius	'09 >	ESTR-0313	135,00
TRIUMPH	SPEED TRIPLE	'06 -'07	ESTR-0701	70,00
	DAYTONA 675	'06 -'10	ESTR-0702	70,00
	STREET TRIPLE +	'07 -'10	ESTR-0703	110,00
	SPEED TRIPLE	'08 -'10	ESTR-0704	149,00
YAMAHA	R6	'06 -'10	ESTR-0208	70,00
	R1	'04 -'08	ESTR-0204	70,00
	R1 (solo scarichi originali / only for original exhaust)	'09 -'10	ESTR-0213	70,00
	R1 (per scarichi aftermarket / for aftermarket exhaust)	'09 -'10	ESTR-0214	70,00
	FZ6 / Fazer	'04 -'10	ESTR-0207	70,00
	FZ1 / Fazer	'06 -'10	ESTR-0209	70,00
	T-MAX	'08 -'10	ESTR-0210	125,00
	YZF-R 125	'08 -'10	ESTR-0211	70,00
XJ6	'09 -'10	ESTR-0212	70,00	

* I portatarga contrassegnati non sono dotati dei supporti per frecce. La moto le ha nel codone

** I portatarga contrassegnati includono parti ricavate dal pieno

+ I portatarga contrassegnati sono forniti completi di luce targa ELT-001

++ I portatarga contrassegnati sono completi di luce targa ELT-001 e supporto porta catarifrangente ELT-003

s.d.: I portatarga contrassegnati hanno uno sconto diversificato

* These license plate holders do not include indicators light kit because the bike includes them on the tail.

** These license plate holders include some pieces which are machined from aluminium billet

+ These license plate holders include the led light ELT001

++ These license plate holders include the led light ELT001 and the reflector support ELT003

s.d. These license plate holders have a different discount.

PORTA TARGA LICENSE PLATE HOLDER

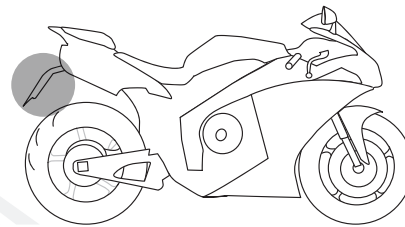

Possibilità di coprire e scoprire l'attacco del dispositivo di illuminazione.
Opzione disponibile solo per alcuni modelli.

*Possibility to cover and uncover the attachment point of led light.
This option is possible only for some models.*

**GARANZIA PRODOTTO 5 ANNI
5 YEARS PRODUCT GUARANTEE**

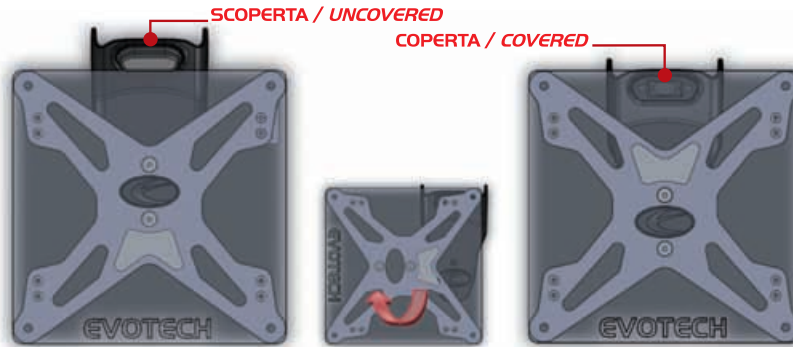

LUCE A LED / LED LIGHT

Dispositivo illuminazione targa con tecnologia LED ad alta luminosità. Il suo piccolo cofanetto in alluminio ricavato dal pieno abbinato ad un elegante colorazione nera satinata, rendono questo semplice componente un gioiello distintivo del proprio mezzo. Il dispositivo è dotato di un circuito elettronico integrato per la stabilizzazione dell'intensità luminosa in condizioni d'uso. Il circuito LED risulta impermeabile e resistente alle condizioni di funzionamento più esasperate. Garantito per 500.000km. Prodotto in fase di omologazione. Design registrato ®

Lighting device for license plate with high brightness LED technology. Its small aluminium case obtained from an aluminium billet matches with an elegant black satinized colour to make of this simple component a jewel to distinguish your vehicle. This accessory is equipped with an integrated electronic circuit for the stabilization of the brightness intensity while in use. The waterproof LED is resistant to the most extreme functioning conditions. Granted for 500.000km. Product waiting for homologation. Registered design ®



ELT-001

25,00

SUPPORTO CATARINFRANGENTE / REAR REFLECTOR SUPPORT

Questa semplice piastrina permette di montare sotto ai portatarga in alluminio il catarifrangente montato in origine sulla motocicletta. Per il montaggio è sufficiente utilizzare due viti o rivetti più lunghi nella parte inferiore della targa e fissarlo contemporaneamente ad essa.

This useful gadget allows you to place the original rear reflector under the license plate support of your bike. To assemble, use two long rivets or screws and fit them on the bottom of the plate.



ELT-003

5,00

FANALE POSTERIORE A LED / REAR STOP LED LIGHT

Fanale con lente bianca, ideale per personalizzare la vostra motocicletta. Leggero e compatto ha un design che si sposa ottimamente con molte motociclette. Il fanale viene consegnato privo di connettori con i cavi tagliati.

This homologated rear light is the best solution to personalize your motorbike. Its shape makes it perfect for many motorbikes. It is shipped without connector and with cut cables.

MISURE DI INGOMBRO / MEASURES	
Larghezza massima / maximum width	140 mm
Lunghezza massima / maximum length	85 mm
Altezza massima / maximum height	40,3 mm
Diametro perni di montaggio / fixing screws diameter	6 mm
Interasse perni di montaggio / fixing screws wheelbase	110 mm



ELT-004

50,00

PORTA TARGA LICENSE PLATE HOLDER

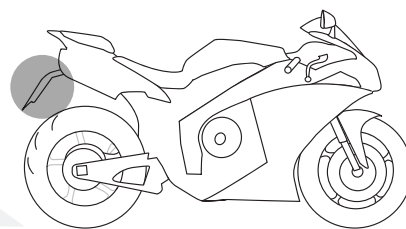

ADATTATORI FRECCE / INDICATORS LIGHT ADAPTERS

Kit completo di piastrine per il montaggio di frecce aftermarket. Il kit comprende due piastrine ricavate dal pieno in alluminio realizzate con la sagoma identica a quella del gambo delle frecce originali in modo da permettere il corretto montaggio di quelle con gambo filettato. Disponibili in 4 colori per un effetto nuovo nella personalizzazione della motocicletta. Consultare il sito per le applicazioni.

Through this useful gadget you can fit the after-market indicators. This kit includes two plates machined from aluminium whose shape is the same as the original indicators shank. This allows you the correct fitting of threaded indicators' shank. They are available in 4 different colours. Visit our web site for the applications.



GARANZIA PRODOTTO 5 ANNI 5 YEARS PRODUCT GUARANTEE

CODICE/CODE	COLORE/COLOUR	EURO w/o tax
AFIL-01	Dn Rg Cr Eb	12,00
AFIL-02	Dn Rg Cr Eb	12,00
AFIL-03	Dn Rg Cr Eb	12,00
AFIL-04	Dn Rg Cr Eb	12,00
AFIL-05	Dn Rg Cr Eb	12,00
AFIL-06	Dn Rg Cr Eb	12,00
AFIL-07	Dn Rg Cr Eb	12,00
AFIL-08	Dn Rg Cr Eb	12,00

SUPPORTI PER FRECCE ORIGINALI / SUPPORTS FOR ORIGINAL INDICATORS LIGHT

Piccolo particolare dal grande pregio qualitativo, utile per chi desidera mantenere l'indicatore di direzione originale sul portatarga Evotech. Realizzati tramite fresatura CNC di alluminio aeronautico dal pieno e successivamente piegati. Disponibili in riferimento per i vari modelli. Consultare l'apposita sezione sul sito web per la scelta del modello.

This high quality accessory, is perfect for those who want to maintain the original indicators light on the Evotech license plate holder. They are first machined from billet aluminium through CNC machineries and then they are being bent. Indicators supports are available for the different model bikes. Visit our web site for the correct model choice.

GARANZIA PRODOTTO 5 ANNI 5 YEARS PRODUCT GUARANTEE



MARCA/BRAND	CODICE/CODE	EURO w/o tax
kit supporto frecce aftermarket	SFK-01	5,00
APRILIA	SFO-10-A	6,50
BENELLI TNT	SFO-06-A	6,50
BMW	SFO-10-A	6,50
DUCATI(modelli vecchi/old models)	SFO-10-A	6,50
DUCATI(modelli nuovi/new models)	SFO-08-A	6,50
HONDA	SFO-01-A	6,50
MV AGUSTA	SFO-05-A	6,50
KAWASAKI	SFO-04-A	6,50
KTM	SFO-09-A	6,50
SUZUKI	SFO-03-A	6,50
TRIUMPH	SFO-10-A	6,50
YAMAHA	SFO-02-A	6,50

TAMPONI DEFENDER

DEFENDER FRAME SLIDERS

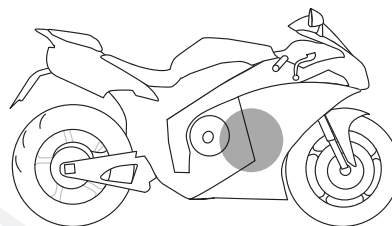

Basi di supporto in alluminio aeronautico ricavato dal pieno mediante macchinari CNC. Il foro particolarmente profondo permette di calibrarne la rigidità e di ridurre gli stress che arrivano al telaio stesso, in modo da ridurre drasticamente la possibilità che esso si spezzi. Ogni base di supporto è identificata da un numero inciso sul retro. In caso di necessità è possibile acquistare solo i ricambi necessari.

Aluminium frame sliders machined from billet aluminum through CNC machines. The hole, which is particularly deep, allows you to regulate the rigidity and to reduce frame stress. In this way the possibility that your frame breaks is reduced. Each slider has a number printed under it which enables you to recognize it and replace it when necessary.

GARANZIA PRODOTTO 5 ANNI
5 YEARS PRODUCT GUARANTEE



Tappo ricavato dal pieno da speciale materiale plastico ad alta resistenza, buon assorbimento dell'urto e altissima resistenza all'abrasione con proprietà autolubrificanti per evitare impuntamenti. Elegante serigrafia laser indelebile, forma ricercata e dimensioni contenute per un migliore impatto estetico. Ogni tampone Defender monta un o-ring tra tappo plastico e base in alluminio, questo accorgimento evita lo smarrimento del tappo durante la guida (causato dalle vibrazioni).

The Derlyn Plug is machined from special plastic material. This material has a low friction coefficient and allows the motorbike to stop gradually during the fall reducing the risk of a roll over. Derlyn plugs have been screen printed by laser. Their unique shape makes our plug esthetically incomparable. Each defender kit has an o-ring placed between the plastic plug and the aluminium pad which prevents the loss of the plug during the driving.



Pratica confezione apri-chiudi. Permette di estrarre e mostrare il prodotto senza rompere la scatola. Cartoncino divisorio anti-graffio per la protezione dei particolari da urti durante il trasporto. Le lettere R e L indicano su che lato della moto va installato il tampone (R = destra, L = sinistra). Istruzioni di montaggio e foto della moto accessoriata sul nostro sito internet.

Comfortable open-close pack which allows you to get out and show the product without breaking the packaging. There is a separating anti-scratch card which protects the product against any bumpy knocks during the transport. The L and R letters sign the motorbike side on which the pad has to be assembled (R=right, L=left). For assembling instruction and images about the motorbike and its accessories visit our web site.



TAMPONI DEFENDER DEFENDER FRAME SLIDERS

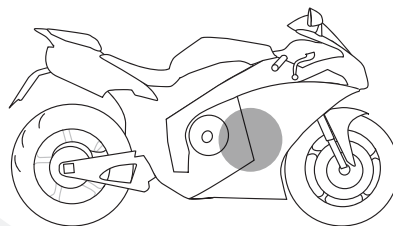

MARCA/BRAND	MODELLO/MODEL	ANNO/YEAR	FORARE/DRILLING SIDE	COLORE/COLOUR	CODICE/CODE	EURO w/o tax
BENELLI	TnT 1130 / 900	'05 -'10		Nero / Black	DEF0601	60,00
	Tre 1130 K	'06 -'10		Nero / Black	DEF0602	60,00
HONDA	HORNET 600	'98 -'06		Nero / Black	DEF0101	42,00
	CBF 600 / N	'04 -'07		Nero / Black	DEF0101	42,00
	HORNET 600	'07 -'10		Nero / Black	DEF0109	42,00
	CBF 600 N / S	'08 >		Nero / Black	DEF0109	42,00
	CB 1000 R	'08 -'10		Nero / Black	DEF0110	42,00
	HORNET 900	'01 -'07		Nero / Black	DEF0105	50,00
	CBR 600 F / Sport	'99 -'06	SX DX	Nero / Black	DEF0102	42,00
	CBR 600 RR	'03 -'06	SX DX	Nero / Black	DEF0103	42,00
	CBR 600 RR	'07 -'10	SX DX	Nero / Black	DEF0108	42,00
	CBR 900 RR	'00 -'03		Nero / Black	DEF0104	42,00
	CBR 1000 RR	'04 -'07	SX DX	Nero / Black	DEF0106	42,00
	CBR 1000 RR	'08 -'10	SX DX	Nero / Black	DEF0111	42,00
	CBF 1000 / ST	'06 -'10		Nero / Black	DEF0107	42,00
KAWASAKI	ZX 6R / RR	'03 -'04		Nero / Black	DEF0401	42,00
	ZX 6R / RR	'05 -'06	SX	Nero / Black	DEF0401	42,00
	ZX 6R	'07 -'08		Nero / Black	DEF0405	42,00
	ZX 6R	'09	SX DX	Nero / Black	DEF0409	42,00
	Z 750	'04 -'06		Nero / Black	DEF0403	50,00
	Z 750	'07 -'10		Nero / Black	DEF0406	50,00
	Z 1000	'07 -'09		Nero / Black	DEF0406	50,00
	Z 1000	'10		Nero / Black	DEF0410	50,00
	ZX 9R	'02 -'04		Nero / Black	DEF0404	42,00
	Z 1000	'03 -'06		Nero / Black	DEF0403	50,00
	ZX10R	'04 -'05	SX DX	Nero / Black	DEF0402	42,00
	ZX10R*	'06 -'07	SX DX	Nero / Black	DEF0402	42,00
	ZX10R	'08 -'10	SX	Nero / Black	DEF0407	42,00
	ZZR 1400	'07 -'10		Nero / Black	DEF0408	50,00
	MV AGUSTA	F4 750 / 1000	<'09	SX DX	Nero / Black	DEF0501
BRUTALE		<'09		Nero / Black	DEF0501	42,00
BRUTALE		'10		Nero / Black	DEF0502	50,00
SUZUKI	GSX-R 600 / 750	'97 -'99		Nero / Black	DEF0301	42,00
	GSX-R 600 / 750	'00 -'03	SX	Nero / Black	DEF0301	42,00
	GSX-R 600 / 750	'04 -'05		Nero / Black	DEF0301	42,00
	GSX-R 600 / 750	'06 -'10	SX	Nero / Black	DEF0306	42,00
	GSX-R 1000	'00 -'02	SX	Nero / Black	DEF0301	42,00
	GSX-R 1000	'03 -'04		Nero / Black	DEF0301	42,00
	GSX-R 1000	'05 -'06		Nero / Black	DEF0305	42,00
	GSX-R 1000	'07 -'08		Nero / Black	DEF0308	42,00
	GSX-R 1000	'09 -'10	SX DX	Nero / Black	DEF0312	42,00
	SV 650 naked / S	'00 -'02		Nero / Black	DEF0304	50,00
	SV 650 naked / S	'03 -'07		Nero / Black	DEF0302	50,00
	SV 650 naked / S	'08 -'09		Nero / Black	DEF0311	50,00
	SV 1000	'03 -'08		Nero / Black	DEF0303	50,00
	B-KING	'08 -'10		Nero / Black	DEF0310	42,00
	GSR 600	'06 -'10		Nero / Black	DEF0307	42,00
GLADIUS	'09 >		Nero / Black	DEF0313	50,00	
TRIUMPH	Speed Triple	'99 -'07		Nero / Black	DEF0701	50,00
	Daytona	'99 -'04		Nero / Black	DEF0701	50,00
	Street Triple	'07 -'09		Nero / Black	DEF0702	50,00
YAMAHA	R1	'02 -'03		Nero / Black	DEF0203	42,00
	R1	'04 -'06		Nero / Black	DEF0204	42,00
	R6	'99 -'02	SX DX	Argento / Silver	DEF0205	42,00
	R6	'03 -'05		Nero / Black	DEF0206	42,00
	R6	'06 -'07	SX	Nero / Black	DEF0208	42,00
	R6	'08 -'10		Nero / Black	DEF0210	42,00
	FZ6 / Fazer / S2	'04 -'10		Nero / Black	DEF0207	42,00
	FZ1 / Fazer	'06 -'10		Nero / Black	DEF0209	42,00
XJ6	'09 >	SX DX	Nero / Black	DEF0212	42,00	
EVOTECH	TAPPO DI RICAMBIO / SPARE PLUG				DEF0001	10,00
	O-RING				DEF0002	0,50

* è necessario sostituire anche il serbatoio di recupero liquido radiatore \ it is necessary to replace the recycled tank of radiator's fluid

STREET DEFENDER KIT

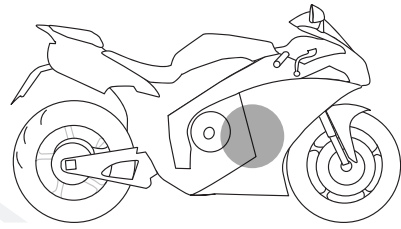

Street Defender



Street Defender



STREET DEFENDER KIT

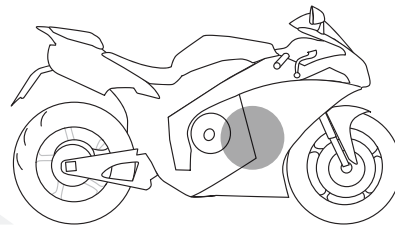

I tamponi paratelaio riescono ad offrire la massima protezione solo se ancorati ad un supporto abbastanza robusto (attacco telaio motore) e mediante bulloni di grande diametro (minimo 10mm). In alcune motociclette tali attacchi sono nascosti dalla carenatura, rendendo necessario modificarla per poter effettuare il montaggio dei tamponi paratelaio Defender. Tamponi imbullonati su supporti alternativi (staffine carena, etc.) non possono garantire una grande protezione della moto e spesso aumentano esponenzialmente i danni causati da una caduta a forte velocità. Per questi motivi EVOTECH, solo ed esclusivamente per le moto dove l'applicazione si è dimostrata valida, ha ideato e realizzato questi kit specifici che consentono di proteggere la motocicletta in maniera veramente efficace, senza richiedere nessuna modifica alla carena per il montaggio.

Defender frame sliders offer the greatest protection only when they are fitted on a solid point (frame-engine attachment) and through bolts with a large diameter (10mm at least). On some motorbikes these connection points are often hidden by the fairing. In this case it is necessary to modify it in order to assemble the crash pads. Frame sliders fixed on other points that are not so tough (frame brackets, etc) can't guarantee in case of fall a good protection. It is for all these reasons that Evotech, only for those motorbikes where the application is efficient, has created these kits. They allow to protect your bike in a very efficient way and without making any modification to the original fairing.



MARCA/BRAND	MODELLO/MODEL	ANNO/YEAR	CODICE/CODE	EURO w/o tax
APRILIA	TUONO R / FACTORY	'06 -'09	STD-A01	100,00
	RSV4	'09-'10	STD-V4	150,00
BMW	S1000RR	'10>	STD-S1000	120,00
DUCATI	Monster 696 / 1100	'08 -'10	STD-D1*	179,00
<small>*scontistica differenziata / different discount</small>				
HONDA	CBR 600 RR	'07 -'08	STD-H06	120,00
	CBR 1000 RR	'05	STD-H10	120,00
	CBR 1000 RR	'06 -'07	STD-H11	120,00
KAWASAKI	ZX6R / RR	'05 -'06	STD-K6	80,00
	ZX6R	'07 -'08	STD-K7	80,00
	ZX6R	'09	STD-K8	120,00
	Z750	'07-'10	STD-K12	90,00
	Z1000	'07-'09	STD-K12	90,00
	ER6-N	'06 -'08	STD-ER6	80,00
	VERSYS	'07 -'09	STD-ER6	80,00
	ER6-N	'09-'10	STD-ER6-2	70,00
KTM	SUPERMOTO 990	'09 >	STD-SM990	100,00
	SUPERDUKE 990	'09 >	STD-SDUKE	100,00
SUZUKI	GSX-R 600 / 750	'06 -'07	STD-GX	100,00
	GSX-R 600 / 750	'08 -'10	STD-GX2	100,00
TRIUMPH	DAYTONA 675	'06 -'10	STD-T675	150,00
	STREET TRIPLE	'07 -'10	STD-T675	150,00
	SPEED TRIPLE	'08 -'10	STD-SPEED	100,00
	TIGER 1050	'07 -'10	STD-TIGER	150,00
YAMAHA	R6	'03 -'05	STD-Y6	80,00
	R6	'06 -'07	STD-Y8	100,00
	R1	'07 -'08	STD-Y9	100,00
	R1	'09-'10	STD-Y11	120,00
	XJ6	'09-'10	STD-Y10	90,00

PARTI DI RICAMBIO

SPARE PARTS

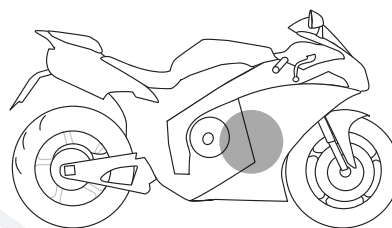

KIT	DESCRIZIONE/DESCRIPTION	CODICE/CODE	EURO w/o tax
APRILIA TUONO '06 -'09	Staffa Dx/Right bracket	STR-A01	50,00
	Tampone alluminio Dx/Right aluminium frame slider	TG-47B	10,00
	Bullone Tampone Dx/Right slider's bolt	M10X100	3,00
	Tampone alluminio Sx/Left aluminium frame slider	TG-15B	10,00
	Boccola Dx/Right ferrule	STR-A01-D	3,00
	Bullone Tampone Sx/Left slider's bolt	M10x140	3,00
APRILIA RSV4 '09-'10	Staffa Dx/Right bracket	STR-RV4-SR	56,00
	Staffa Sx/Left bracket	STR-RV4-SL	56,00
	Tampone alluminio Dx/Right aluminium frame slider	TG-07B	10,00
	Tampone alluminio Sx/Left aluminium frame slider	TG-06B	10,00
	Bullone Tampone Dx/Right slider's bolt	M10X40	3,00
	Bullone Tampone Sx/Left slider's bolt	M10X40	3,00
	Bullone Staffa Sx/Left bracket's bolt	M10X75 1.5	3,00
	Bullone Staffa Dx/Right bracket's bolt	M10X90 1.5	3,00
	Blocchetto staffa/bracket ferrule	STR-RV4-B1	12,00
Blocchetto staffa/bracket ferrule	STR-RV4-B2	12,00	
BMW S1000RR '10	Staffa Dx/Right bracket	STR-S1000-SR	55,00
	Staffa Sx/Left bracket	STR-S1000-SL	55,00
	Tampone alluminio Dx/Right aluminium frame slider	TG-33B	10,00
	Tampone alluminio Sx/Left aluminium frame slider	TG-33B	10,00
	Bullone Tampone Dx/Right slider's bolt	M10X50	3,00
	Bullone Tampone Sx/Left slider's bolt	M10X50	3,00
	Bullone staffa Sx/Left bracket's bolt	M10X60 1.5	3,00
DUCATI MONSTER 696/1100	Staffa Dx/Right bracket	STR-MON-SR	68,00
	Staffa Sx/Left bracket	STR-MON-SL	68,00
	Tampone alluminio Dx/Right aluminium frame slider	TG-42B	10,00
	Tampone alluminio Sx/Left aluminium frame slider	TG-07B	10,00
	Bullone Tampone Dx/Right slider's bolt	M10X40	3,00
	Bullone Tampone Sx/Left slider's bolt	M10X40	3,00
	Special bolts Dx-Sx/Special right and left ferrule	STR-MON-V	14,00
	Boccola Sx/Left ferrule	STR-MON-B1	11,00
	Boccola Dx/Right ferrule	STR-MON-B2	11,00
Perno inox/Inox bolt	STR-MON-P	24,00	
HONDA CBR 600 RR '07 -'08	Staffa Sx/Left bracket	STR-H06SL	55,00
	Staffa Dx/Right bracket	STR-H06SR	55,00
	Tampone alluminio Sx/Left aluminium frame slider	DEF0033	10,00
	Tampone alluminio Dx/Right aluminium frame slider	DEF0006	10,00
	Bullone Tampone Sx/Left slider's bolt	M10X50	3,00
	Bullone Tampone Dx/Right slider's bolt	M10X50	3,00
HONDA CBR 1000 RR '05	Staffa Sx/Left bracket	STR-H10SL	45,00
	Staffa Dx/Right bracket	STR-H10SR	45,00
	Tampone alluminio/Aluminium frame slider	DEF0020	10,00
	Bullone Staffa Sx/Left bracket's bolt	M12X70	3,00
	Bullone Staffa Dx/Right bracket's bolt	M12X80	3,00
	Bullone Tampone/Frame slider's bolt	M10X40	3,00
	Bullone M6 Staffe/M6 bracket's bolt	M6X20	1,00

GARANZIA PRODOTTO 5 ANNI
5 YEARS PRODUCT GUARANTEE

PARTI DI RICAMBIO SPARE PARTS

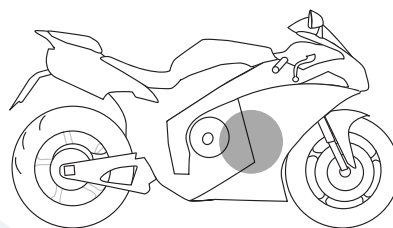

KIT	DESCRIZIONE/DESCRIPTION	CODICE/CODE	EURO w/o tax
HONDA CBR 1000 RR '06 -'07	Staffa Sx / <i>Left bracket</i>	STR-H11SL	45,00
	Staffa Dx / <i>Right bracket</i>	STR-H11SR	45,00
	Tampone alluminio / <i>Aluminium frame slider</i>	DEF0020	10,00
	Bullone Staffa Sx / <i>Left bracket's bolt</i>	M12X80	3,00
	Bullone Staffa Dx / <i>Right bracket's bolt</i>	M12X90	3,00
	Bullone tampone / <i>Frame slider's bolt</i>	M10X40	3,00
	Distanziale carene con grano / <i>Fairing spacer</i>	STR-H11D	2,00
KAWASAKI ZX6R / RR '05 -'06	Staffa Sx / <i>Left bracket</i>	STR-K6S	40,00
	Bullone di fissaggio staffa / <i>Bracket's bolt</i>	M10X70	3,00
	Tampone Sx nero / <i>Left frame slider</i>	DEF0017	10,00
	Tampone Dx nero / <i>Right frame slider</i>	DEF0016	10,00
	Bullone Tampone Sx / <i>Left slider's bolt</i>	M10X70	3,00
	Bullone Tampone Dx / <i>Right slider's bolt</i>	M10X100	3,00
KAWASAKI ZX6R '07 -'08	Staffa Dx / <i>Right bracket</i>	STR-K7D	40,00
	Bullone di fissaggio staffa / <i>Bracket's bolt</i>	M10X70	3,00
	Tampone Sx nero / <i>Left frame slider</i>	DEF0019	10,00
	Tampone Dx nero / <i>Right frame slider</i>	DEF0009	10,00
	Bullone Tampone Sx / <i>Left slider's bolt</i>	M10X100	3,00
	Bullone Tampone Dx / <i>Right slider's bolt</i>	M10X50	3,00
KAWASAKI ZX6R '09	Staffa Sx / <i>Left bracket</i>	STR-K8SL	40,00
	Staffa Dx / <i>Right bracket</i>	STR-K8SR	40,00
	Bullone Staffa Sx / <i>Left bracket's bolt</i>	M10X50	3,00
	Bullone Staffa Dx / <i>Right bracket's bolt</i>	M10X60	3,00
	Ghiera speciale / <i>special ring nut</i>	STR-K8-G	2,00
	Tampone Sx / <i>Left frame slider</i>	DEF0042	10,00
	Tampone Dx / <i>Right frame slider</i>	DEF0037	10,00
	Bullone Tampone Sx / <i>Left slider's bolt</i>	M10X50	3,00
	Bullone Tampone Dx / <i>Right slider's bolt</i>	M10X60	3,00
KAWASAKI ER - 6N / VERSYS	Staffa Sx / <i>Left bracket</i>	STR-ER6SL	20,00
	Staffa Dx / <i>Right bracket</i>	STR-ER6SR	20,00
	Bullone Staffa Sx / <i>Left bracket's bolt</i>	M10X60	3,00
	Bullone Staffa Dx / <i>Right bracket's bolt</i>	M10X100	3,00
	Base tampone alluminio Sx / <i>Left aluminium frame slider</i>	DEF0023	10,00
	Base tampone alluminio Dx / <i>Right aluminium frame slider</i>	DEF0042	10,00
	Bullone tampone Sx / <i>Left slider's bolt</i>	M10X60	3,00
	Bullone tampone Dx / <i>Right sliders's bolt</i>	M10X40	3,00
KAWASAKI ER-6N '09	Staffa Dx / <i>Right bracket</i>	STR-ER62SR	20,00
	Bullone Staffa Dx / <i>Right bracket's bolt</i>	M10X80	3,00
	Base tampone alluminio Sx / <i>Left aluminium frame slider</i>	DEF0023	10,00
	Base tampone alluminio Dx / <i>Right aluminium frame slider</i>	DEF0042	10,00
	Bullone Tampone Sx / <i>Left slider's boltw</i>	M10X60	3,00
	Bullone Tampone Dx / <i>Right slider's bolt</i>	M10X40	3,00
KAWASAKI Z750 '07- '10	Staffa Dx / <i>Right bracket</i>	STR-K12	40,00
	Staffa Sx / <i>Left bracket</i>	STR-K12	40,00
	Tampone alluminio Dx / <i>Right aluminium frame slider</i>	TG-20B	10,00
	Tampone alluminio Sx / <i>Left aluminium frame slider</i>	TG-42B	10,00
	Bullone Tampone Dx / <i>Right slider's bolt</i>	M10X40	3,00
	Bullone Tampone Sx / <i>Left slider's boltw</i>	M10X40	3,00
	Bullone di fissaggio staffa / <i>Bracket's bolt</i>	TCCE M8X50	3,00
	Bullone di fissaggio staffa / <i>Bracket's bolt</i>	TCCE M8X50	3,00

PARTI DI RICAMBIO SPARE PARTS

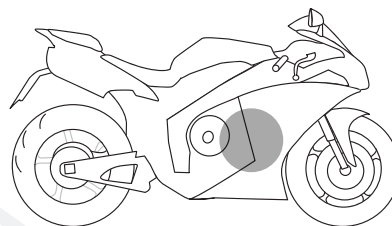

KIT	DESCRIZIONE/DESCRIPTION	CODICE/CODE	EURO w/o tax
KTM SUPERMOTO 990	Staffa Dx/ Right bracket	STR-LC8	45,00
	Staffa Sx/ Left bracket	STR-LC8	45,00
	Base tampone alluminio Dx/ Right aluminium frame slider	TG-23B	10,00
	Base tampone alluminio Sx/ Left aluminium frame slider	TG-23B	10,00
	Bullone Tampone Dx/ Right slider's bolt	M10X60	3,00
	Bullone Tampone Sx/ Left slider's boltw	M10X60	3,00
	Bullone di fissaggio staffa/ Bracket's bolt	M10X40 1.5	3,00
KTM 990 SUPERDUKE/R	Staffa Dx/ Right bracket	STR-LC8	45,00
	Staffa Sx/ Left bracket	STR-LC8	45,00
	Base tampone alluminio Dx/ Right aluminium frame slider	TG-23B	10,00
	Base tampone alluminio Sx/ Left aluminium frame slider	TG-19B	10,00
	Bullone Tampone Dx/ Right slider's bolt	M10X60	3,00
	Bullone Tampone Sx/ Left slider's boltw	M10X60	3,00
	Bullone di fissaggio staffa/ Bracket's bolt	M10X40 1.5	3,00
SUZUKI GSX-R 600 / 750 '06 -'07	Staffa Sx/ Left bracket	STR-GX	60,00
	Bullone di fissaggio staffa/ Bracket's bolt	M10X60	3,00
	Base tampone alluminio Sx/ Left frame slider	DEF0007	10,00
	Base tampone alluminio Dx/ Right frame slider	DEF0020	10,00
	Bullone Tampone Sx/ Left slider's bolt	M10X50	3,00
	Bullone Tampone Dx/ Right slider's bolt	M10X70	3,00
SUZUKI GSX-R 600 / 750 '08 -'09	Staffa Sx/ Left bracket	STR-GX2	60,00
	Bullone di fissaggio staffa/ Bracket's bolt	M10X60	3,00
	Base tampone alluminio Sx/ Left frame slider	DEF0007	10,00
	Base tampone alluminio Dx/ Right frame slider	DEF0020	10,00
	Bullone Tampone Sx/ Left slider's bolt	M10X50	3,00
	Bullone Tampone Dx/ Right slider's bolt	M10X70	3,00
TRIUMPH DAYTONA 675	Staffa Sx/ Left bracket	STR-T6S	50,00
	Staffa Dx/ Right bracket	STR-T6D	50,00
	Distanziale Sx/ Left spacer	STR-T6LD	8,00
	Distanziale Dx/ Right spacer	STR-T6RD	8,00
	Bullone di fissaggio staffa Sx/ Left bracket's bolt	M10X120	3,00
	Bullone di fissaggio Staffa Dx/ Right bracket's bolt	M10X120	3,00
	Base tampone alluminio Sx/ Left frame slider	DEF0041	10,00
	Base tampone alluminio Dx/ Right frame slider	DEF0007	10,00
	Bullone Tampone Dx/ Right slider's bolt	M10X40	3,00
	Bullone Tampone Sx/ Left slider's bolt	M10X70	3,00
YAMAHA R6 '03 -'05	Staffa Dx/ Right bracket	STR-Y6S	40,00
	Bullone di fissaggio staffa/ Bracket's bolt	M10X50	3,00
	Base tampone alluminio Sx/ Left frame slider	DEF0033	10,00
	Base tampone alluminio Dx/ Right frame slider	DEF0006	10,00
	Bullone Tampone Sx/ Left slider's bolt	M10X60	3,00
	Bullone Tampone Dx/ Right slider's bolt	M10X50	3,00
YAMAHA R6 '06 -'07	Staffa Sx/ Left bracket	STR-Y8	60,00
	Bullone di fissaggio staffa/ Bracket's bolt	M10X60	3,00
	Base tampone alluminio Sx/ Left frame slider	DEF0017	10,00
	Base tampone alluminio Dx/Right frame slider	DEF0007	10,00
	Bullone Tampone Sx/ Left slider's bolt	M10X70	3,00
	Bullone Tampone Dx/ Right slider's bolt	M10X70	3,00

PARTI DI RICAMBIO SPARE PARTS

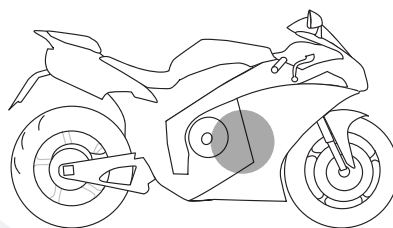

KIT	DESCRIZIONE/DESCRIPTION	CODICE/CODE	EURO w/o tax
YAMAHA R1 '07-'08	Staffa Sx/Left bracket	STR-Y9SL	40,00
	Staffa Dx/Right bracket	STR-Y9SR	40,00
	Bullone Staffa Sx/Left bracket's bolt	M10X60	3,00
	Vite carter-staffa Sx (1pz)/Left bracket cover's screw	M6X35	0,50
	Bullone Staffa Dx/Right bracket's bolt	M10X60	3,00
	Base tampone alluminio Sx/Left frame slider	DEF0041	10,00
	Base tampone alluminio Dx/Right frame slider	DEF0042	10,00
	Bullone Tampone Sx/Left slider's bolt	M10X70	3,00
	Bullone Tampone Dx/Right slider's bolt	M10X40	3,00
YAMAHA R1 '09	Staffa Dx/Right bracket	STR-Y11SR	45,00
	Staffa Sx/Left bracket	STR-Y11SL	45,00
	Bullone Staffa Sx/Left bracket's bolt	M12X60	3,00
	Base tampone alluminio Sx/Left frame slider	DEF0020	10,00
	Base tampone alluminio Dx/Right frame slider	DEF0037	10,00
	Bullone Tampone Sx/Left slider's bolt	M10X40	3,00
	Bullone Tampone Dx/Right slider's bolt	M10X60	3,00
	Boccola Sx/Left ferrule	STR-Y11-B1	1,50
	Boccola Dx/Right ferrule	STR-Y11-B2	0,70
YAMAHA XJ6 '09	Staffa Dx/Right bracket	STR-Y10SR	40,00
	Staffa Sx/Left bracket	STR-Y10SL	40,00
	Bullone Staffa Dx/Right bracket's bolt	M6X35	4,00
	Base tampone alluminio Dx/Right frame slider	DEF0020	10,00
	Bullone Tampone Dx/Right slider's bolt	M10X40	3,00
	Bullone Staffa Sx/Left bracket's bolt	M6X35	3,00
	Base tampone alluminio Sx/Left frame slider	DEF0042	10,00
Bullone Tampone Sx/Left slider's bolt	M10X40	3,00	
SPEED TRIPLE	Staffa Dx/Right Bracket	STR-SPEED	40,00
	Bullone staffa Dx/Right bracket's bolt	M12X70	3,00
	Base tampone alluminio Dx/Right frame slider	DEF0039	10,00
	Bullone tampone Dx/Right slider's bolt	M12X80	3,00
	Base tampone alluminio Sx/Left frame slider	DEF0038	10,00
	Bullone tampone Sx/Left slider's bolt	M12X120	3,00
TIGER 1050	Staffa Dx/Right bracket	STR-TIGERSR	40,00
	Staffa Sx/Left Bracket	STR-TIGERSL	40,00
	Bullone Staffa Dx/Right bracket's bolt	M12x80	3,00
	Base tampone alluminio Dx/Right frame slider	DEF0018	10,00
	Bullone tampone Dx/Right slider's bolt	M10X80	3,00
	Bullone Staffa Sx/Left bracket's bolt	M12X50	3,00
	Base tampone alluminio Sx/Left frame slider	DEF0018	10,00

TAPPI CINGHIA ALUMINIUM PLUGS

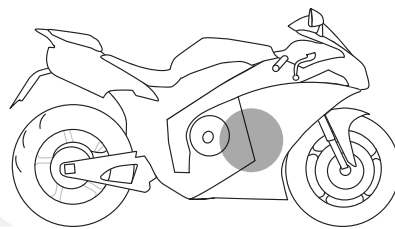

Il metodo più pratico e sicuro per legare la moto sul carrello o sul furgone. v Basta con graffi alle carene, piastre di sterzo e manubri dovuti alle cinghie che strisciano. È sufficiente sostituire i tappi in alluminio a quelli in derlyn. Si possono applicare ai nostri tamponi Defender, ai Kit Street Defender e ai Protector. L'operazione non richiede l'uso di nessun attrezzo e il tutto si esegue in pochi secondi. Interamente ricavati dal pieno da barre di alluminio mediante tornitura e fresatura CNC. Il foro di grande diametro consente il passaggio di cinghie di grande sezione. La pratica confezione apri-chiudi permette di conservarli in ordine quando non usati.

By replacing the derlyn plugs with this special aluminium plugs, the frame sliders become the safest and most practical system to tie your motorbike on the van! Say stop to the scratches on the fairing panels made by the belts make, semi-handlebars, fairing, say stop to those tie systems on the grips that little by little will ruin them! Great resistance thanks to the working of a single block of a special alloy by sophisticated numerical control machineries. The hole has a big diameter to allow the passage of big cables or belts.

**GARANZIA PRODOTTO 5 ANNI
5 YEARS PRODUCTS GUARANTEE**



PROTECTOR

PROTEZIONE MOTORE

ENGINE PROTECTOR

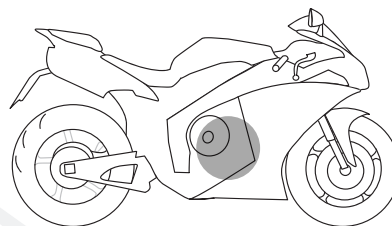

Su alcune moto, nonostante i tamponi Defender contribuiscano a ridurre in maniera significativa i danni riportati in seguito ad una scivolata, i carter del motore possono rimanere esposti. Per queste motociclette abbiamo sviluppato una protezione aggiuntiva per i carter. Sulla R1 '04-'06 proponiamo un tampone che sostituisce il dado del forcellone. Sulla nuova Yamaha R6 (a partire dal 2006) abbiamo invece realizzato una "saponetta" in alluminio che viene fissata direttamente sopra al carter del pick-up accensione. Per la nuova Kawasaki ZX6R abbiamo creato una protezione carter destro e sinistro e una protezione per il carter rinvio del motorino di avviamento, realizzate tramite asportazione di truciolo in Alluminio aeronautico. La linea avvolgente è stata studiata utilizzando tecniche di prototipazione rapida, realizzando il miglior compromesso tra design e compatibilità con parti motore e carenature di serie. Inoltre i componenti sono stati sottoposti ad analisi FEM per ottimizzare il peso mantenendo tuttavia un'ottima resistenza meccanica in caso di caduta.

Even though during a fall our Street Defender avoid most damages, in some motorbikes the engine needs more defense. The components have been checked by FEM analysis to optimize its weight but keeping the best mechanical resistance in case of fall. Evotech chain guards have been thought because some championships in the motorcycle world establish a clause with the obligation to protect the engine parts which, in case of fall, might become perforated and dirty the course by losing the lubricant. For this reason Evotech decided to create this accessory that combines the functional aspects with the elegance and the originality typical of all our products.

GARANZIA PRODOTTO 5 ANNI
5 YEARS PRODUCT GUARANTEE



PRO-0469-B



PRO-0210

PRO-0469-A

MARCA/BRAND	MODELLO/MODEL	ANNO/YEAR	CODICE/CODE	COLORE/COLOUR	EURO w/o tax
YAMAHA	R1	'04-'06	PRO 0204	Dn / /	36,00
	R6	'06-'10	PRO 0210	Dn / /	40,00
KAWASAKI	ZX6R	'09 >	PRO 0469-A	Dn / /	80,00
	ZX6R	'09 >	PRO 0469-B	Dn Si Rg	100,00
	ZX6R	'09 >	PRO 0469-C	Dn / /	190,00

GEMS OF THE WIND

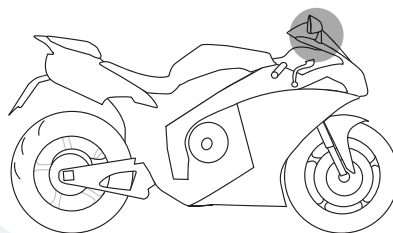

Per la guida in pista è sempre consigliabile smontare gli specchi originali. Ma come fissare la carena originale al telaio, coprendo gli antiestetici fori che rimangono? Queste piastrine sono la soluzione. Abbiamo dato loro un aspetto simile a delle vere e proprie gemme preziose, e le abbiamo battezzate appunto... le gemme del vento!
Disponibili in 6 colori brillanti, impreziosite dal logo serigrafato, donano sicuramente un tocco di ricercatezza alla vostra moto da pista.

To drive on a track it is advisable to take off the original mirrors.. But how can You fix the original fairing to the frame hiding the not so attractive holes that will remain? These small tags are the right solution. We have given them the aspect of real precious gems, and here comes their name... Gems of the wind! You can choose among 6 different gleaming colours, all with their silk screen, giving them a refined touch to Your motorbike while on the track, or in any occasion in which you want to show it off (sporting events, fairs etc..)



GARANZIA PRODOTTO 5 ANNI
5 YEARS PRODUCT GUARANTEE



MARCA/BRAND	MODELLO/MODEL	ANNO/YEAR	CODICE/CODE	COLORI/COLOUR	EURO w/o tax
APRILIA	RSV4 FACTORY/R	'09	GW-V4	Si Dn Ti Rg Cr Eb	32,00
BMW	S1000 RR	'09 >	GW-YA3-B	Si Dn Ti Rg Cr Eb	32,00
HONDA	HORNET 600 S	'98-'06	GW-HO	Si Dn Ti Rg Cr Eb	32,00
	CBR 600 F	'99-'06	GW-HO	Si Dn Ti Rg Cr Eb	32,00
	CBR 600 RR	'03-'10	GW-HO	Si Dn Ti Rg Cr Eb	32,00
	CBR 929 RR	'00-'01	GW-HO	Si Dn Ti Rg Cr Eb	32,00
	CBR 954 RR	'02-'03	GW-HO	Si Dn Ti Rg Cr Eb	32,00
	VTR SP 1/2	/	GW-HO	Si Dn Ti Rg Cr Eb	32,00
	CBR 1000 RR	'04-'07	GW-HO	Si Dn Ti Rg Cr Eb	32,00
KAWASAKI	ZX6R/RR	'03-'04	GW-KA1	Si Dn Ti Rg Cr Eb	32,00
	ZX6R	'09 >	GW-KA3	Si Dn Ti Rg Cr Eb	32,00
	ER-6F	'06-'08	GW-KA1	Si Dn Ti Rg Cr Eb	32,00
	ZX6R/RR	'05-'07	GW-KA2	Si Dn Ti Rg Cr Eb	32,00
	ZX10R	'04-'10	GW-KA2	Si Dn Ti Rg Cr Eb	32,00
SUZUKI	GSX-R 600/750	'00-'05	GW-SU	Si Dn Ti Rg Cr Eb	32,00
	GSX-R 1000	'00-'04	GW-SU	Si Dn Ti Rg Cr Eb	32,00
	GSX-R 600/750	'06-'10	GW-S2	Si Dn Ti Rg Cr Eb	32,00
	GSX-R 1000	'05-'10	GW-S2	Si Dn Ti Rg Cr Eb	32,00
	SV 650 S	'00-'09	GW-SU	Si Dn Ti Rg Cr Eb	32,00
	SV 1000 S	'03-'08	GW-SU	Si Dn Ti Rg Cr Eb	32,00
YAMAHA	R1	'98-'06	GW-YA	Si Dn Ti Rg Cr Eb	32,00
	R6	'99-'07	GW-YA	Si Dn Ti Rg Cr Eb	32,00
	R6	'08-'10	GW-YA2	Si Dn Ti Rg Cr Eb	32,00
	R1	'09 >	GW-YA3	Si Dn Ti Rg Cr Eb	32,00
	R1	'07-'08	GW-KA1	Si Dn Ti Rg Cr Eb	32,00
	FAZER 1000	'02-'03	GW-YA	Si Dn Ti Rg Cr Eb	32,00
	T-MAX	'07	GW-MAX	Si Dn / Rg Cr Eb	45,00

FINAL STORM

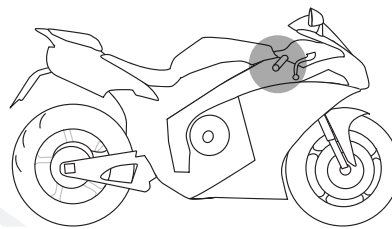

Contrappesi manubrio specifici per ogni modello di moto. Ricavati dal pieno in lega leggera di alluminio mediante tornitura CNC. Vantano un design decisamente innovativo e la massima cura di ogni dettaglio. Ogni articolo ha l'attacco identico all'originale, rendendo semplice e rapido il montaggio. Nei modelli dove il fissaggio viene effettuato tramite una vite, quest'ultima viene fornita in ergal anodizzata nella stessa tinta del contrappeso.

Bar end counterbalances machined from billet aluminium.

They boast a definitely innovative design and the maximal carefulness in each detail. The attach point is the same as the original one, for this reason the assembly is easy and fast.

The bolts are made of anodized ergal in the same colour of the bar ends.

You can choose among 6 wonderful anodized colours.

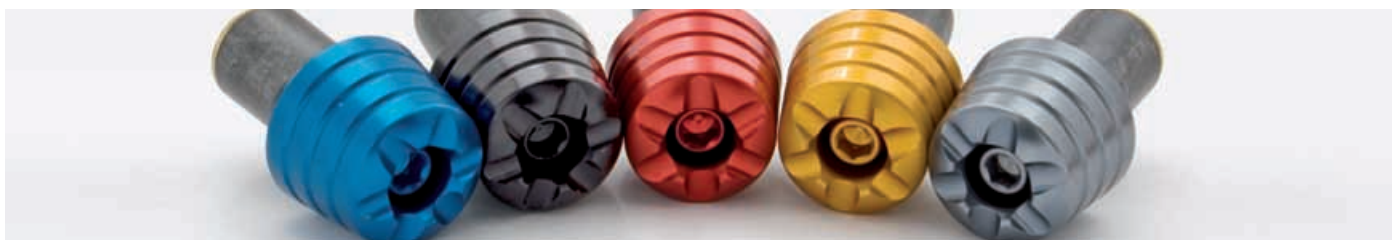

MARCA/BRAND	MODELLO/MODEL	ANNO/YEAR	CODICE/CODE	COLORI/COLOUR	EURO w/o tax
	UNIVERSALE / UNIVERSAL		FS-U	Si Dn Ti Rg Cr Eb	22,50
APRILIA	TUONO / RSV / RSV4	'05-'10	FS-BE	Si Dn Ti Rg Cr Eb	22,50
	RS 125	'07-'10	FS-SU-B	Si Dn Ti Rg Cr Eb	22,50
	SHIVER	'08-'10	FS-BE	Si Dn Ti Rg Cr Eb	22,50
BENELLI	TnT / Trek	/	FS-BE	Si Dn Ti Rg Cr Eb	22,50
BMW	S1000 RR	/	FS-BMW	Si Dn Ti Rg Cr Eb	70,00
DUCATI	Tutte eccetto ST2 e S4 / except for ST2, S4		FS-U	Si Dn Ti Rg Cr Eb	22,50
HONDA	HORNET 600 / 900	tutte / all	FS-HO	Si Dn Ti Rg Cr Eb	22,50
	CBR 600 F / Sp	'99-'06	FS-HO	Si Dn Ti Rg Cr Eb	22,50
	CBR 600 RR	'03-'10	FS-HO	Si Dn Ti Rg Cr Eb	22,50
	CBR 900 RR	'00-'03	FS-HO	Si Dn Ti Rg Cr Eb	22,50
	VTR SP1 / 2	'01-'03	FS-HO	Si Dn Ti Rg Cr Eb	22,50
	CB 1300	'08-'10	FS-HO	Si Dn Ti Rg Cr Eb	22,50
	CB 1000 R	'08-'10	FS-HO	Si Dn Ti Rg Cr Eb	22,50
	CBF 600 / N	'08-'10	FS-HO	Si Dn Ti Rg Cr Eb	22,50
	CBR 1000 RR	'04-'10	FS-HO	Si Dn Ti Rg Cr Eb	22,50
KAWASAKI	ZX6R / RR	'98-'06	FS-KA1	Si Dn Ti Rg Cr Eb	22,50
	ZX6R	'07-'10	FS-KA2	Si Dn Ti Rg Cr Eb	22,50
	ZX9R	'00-'04	FS-KA1	Si Dn Ti Rg Cr Eb	22,50
	Z1000 / 750	'03-'10	FS-KA1	Si Dn Ti Rg Cr Eb	22,50
	ZX10R	'04-'10	FS-KA2	Si Dn Ti Rg Cr Eb	22,50
	ER-6N / F - VERSYS	'06-'10	FS-KA1	Si Dn Ti Rg Cr Eb	22,50
MV AGUSTA	F4 / BRUTALE	< '09	FS-MV	Si Dn Ti Rg Cr Eb	22,50
	BRUTALE	'10	FS-U	Si Dn Ti Rg Cr Eb	22,50

FINAL STORM

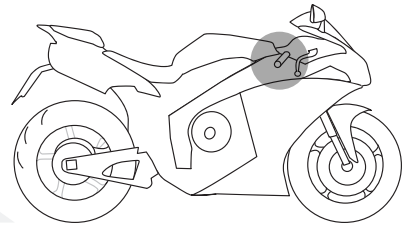

GARANZIA PRODOTTO 5 ANNI
5 YEARS PRODUCT GUARANTEE

MARCA/BRAND	MODELLO/MODEL	ANNO/YEAR	CODICE/CODE	COLORI/COLOUR	EURO w/ o tax
SUZUKI	GSX-R 600/750	'00-'05	FS-U	Si Dn Ti Rg Cr Eb	22,50
	GSX-R 1000	'00-'04	FS-U	Si Dn Ti Rg Cr Eb	22,50
	GSX-R 600/750	'06-'10	FS-SU	Si Dn Ti Rg Cr Eb	22,50
	GSX-R 1000	'05-'10	FS-SU	Si Dn Ti Rg Cr Eb	22,50
	SV 650 S	'00-'09	FS-U	Si Dn Ti Rg Cr Eb	22,50
	SV 1000 S	'03-'09	FS-U	Si Dn Ti Rg Cr Eb	22,50
	GSR 600	'06-'10	FS-U	Si Dn Ti Rg Cr Eb	22,50
	B-King	'08-'10	FS-U	Si Dn Ti Rg Cr Eb	22,50
TRIUMPH	SPEED TRIPLE	'05-'10	FS-U	Si Dn Ti Rg Cr Eb	22,50
YAMAHA	R1	'98-'10	FS-YA1	Si Dn Ti Rg Cr Eb	22,50
	R6	'99-'05	FS-YA2	Si Dn Ti Rg Cr Eb	22,50
	FZ6	'04-'10	FS-YA3	Si Dn Ti Rg Cr Eb	22,50
	FAZER 1000	'02-'04	FS-YA3	Si Dn Ti Rg Cr Eb	22,50
	TDM 900/T-Max	/	FS-YA3	Si Dn Ti Rg Cr Eb	22,50
	R6	'06-'10	FS-YA1	Si Dn Ti Rg Cr Eb	22,50
	FZ1 Naked	'06-'10	FS-YA1	Si Dn Ti Rg Cr Eb	22,50
	FZ1 Fazer	'06-'10	FS-YA3	Si Dn Ti Rg Cr Eb	22,50
	XJ6	'09	FS-YA3	Si Dn Ti Rg Cr Eb	22,50

PADDOCK STANDS

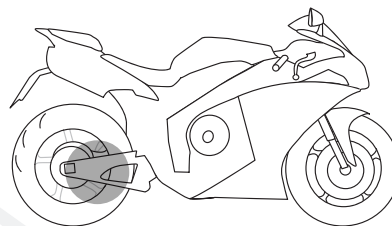

Nottolini cavalletto ricavati dal pieno da barre di lega aeronautica mediante sofisticate macchine a controllo numerico. Vantano un design decisamente nuovo per questo tipo di accessorio, donando un tocco di sportività ed eleganza ad ogni moto sportiva o naked. La lavorazione riprende il gusto estetico dei contrappesi manubrio "Final Storm" e conferisce alle motociclette che montano entrambi i nostri prodotti continuità stilistica. Robustissimi, grazie al grande diametro del corpo, si rivelano sicuri durante il trasporto della moto, evitando che la moto possa cadere dal cavalletto in seguito a scossoni. Grazie alla costruzione monolitica in alluminio evitano di rompere l'attacco del forcellone in seguito ad una scivolata. Per il montaggio basta usare una normale chiave a brugola. Garanzia prodotto 5 anni.

This component has been completely machined from a single block made of a special aeronautic alloy. Thanks to sophisticated numerical control machineries, these items boast a new design in any aspects, giving a sports and elegant touch to every motorbike, sports or naked ones. The style is the same as our "Final Storm" handlebar counterbalances giving the motorcycles that wear these two components a sophisticated fashion and a continuity of style. Evotech paddock standas bobbins are machined from billet aluminium and they are extremely solid thanks also to the big diameter of the piece. They secure the bikes also during the transportation, avoiding any possible fall from the trestle. For the assembling you only need an Allen key. 5 years product guarantee.

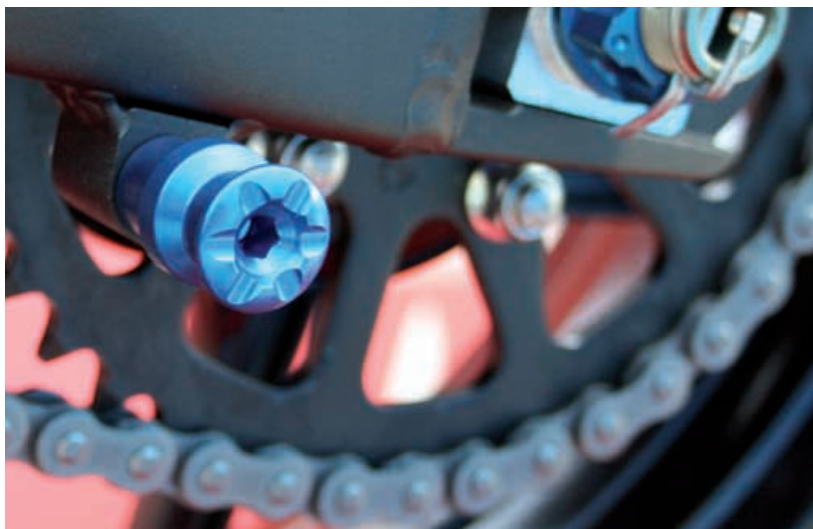

MARCA/BRAND	MODELLO/MODEL	ANNO/YEAR	CODICE/CODE	COLORI/COLOUR	EURO w/o tax
APRILIA	RSV 1000 R / Factory / RSV4	'05 -'10	PS-M6b	Sf Dn Ti Rg Cr Eb	15,00
	TUONO 1000 R / Factory	'06 -'09	PS-M6b	Sf Dn Ti Rg Cr Eb	15,00
	Dorsoduro, Shiver, RS125	'08 -'10	PS-M6	Sf Dn Ti Rg Cr Eb	15,00
BMW	S1000 RR	'10 >	PS-M8b	Sf Dn Ti Rg Cr Eb	15,00
DUCATI	749/999 base / S / R	'05 -'07	PS-M8	Sf Dn Ti Rg Cr Eb	15,00
HONDA	tutti gli altri modelli / all other models	/	PS-M8	Sf Dn Ti Rg Cr Eb	15,00
	CBR 600 RR	'07 -'10	PS-M8b	Sf Dn Ti Rg Cr Eb	15,00
KAWASAKI	ZX6 R / RR	'03 -'06	PS-M10	Sf Dn Ti Rg Cr Eb	15,00
	ZX6R	'07 -'10	PS-M10b	Sf Dn Ti Rg Cr Eb	15,00
	Z 1000	'03 -'06	PS-M10	Sf Dn Ti Rg Cr Eb	15,00
	ZX 10R	'04 -'05	PS-M10	Sf Dn Ti Rg Cr Eb	15,00
	Z 750 / S	'04 -'10	PS-M10b	Sf Dn Ti Rg Cr Eb	15,00
	ER-6N / F	'05 -'07	PS-M10b	Sf Dn Ti Rg Cr Eb	15,00
	ZX 10R	'06 -'07	PS-M10b	Sf Dn Ti Rg Cr Eb	15,00
	Z 1000	'07 -'10	PS-M10b	Sf Dn Ti Rg Cr Eb	15,00
	VERSYS	'07 -'09	PS-M10b	Sf Dn Ti Rg Cr Eb	15,00
ZX 10R	'08 -'10	PS-M10	Sf Dn Ti Rg Cr Eb	15,00	
KTM	filetto / thread M10 x 1,5	/	PS-M10c	Sf Dn Or	15,00
SUZUKI	GSX-R 600 / 750	'97 -'03	PS-M8	Sf Dn Ti Rg Cr Eb	15,00
	GSX-R 1000	'01 -'02	PS-M8	Sf Dn Ti Rg Cr Eb	15,00
	SV 650 / S	'00 -'09	PS-M8	Sf Dn Ti Rg Cr Eb	15,00
	GSX-R 600 / 750	'04 -'10	PS-M8b	Sf Dn Ti Rg Cr Eb	15,00
	GSX-R 1000	'03 -'10	PS-M8b	Sf Dn Ti Rg Cr Eb	15,00
	SV 1000 / S	'03 -'08	PS-M8b	Sf Dn Ti Rg Cr Eb	15,00
	GSR 600	'06 -'10	PS-M8b	Sf Dn Ti Rg Cr Eb	15,00
	HAYABUSA	tutte / all	PS-M8b	Sf Dn Ti Rg Cr Eb	15,00
	B-KING	'08 -'10	PS-M8b	Sf Dn Ti Rg Cr Eb	15,00
YAMAHA	tutte con foro M6 / M6 hole	/	PS-M6	Sf Dn Ti Rg Cr Eb	15,00

Si consiglia di applicare del frenafiletti leggero solo sul modello PS-M6 / We suggest to apply some thread glue only for the PS-M6 models

BLOCCHETTI TENDICATENA AXIAL BLOCKS

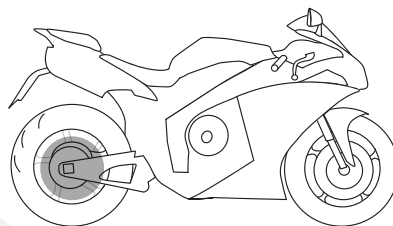

Alle splendide moto Ktm, Evotech dedica una serie di accessori di pregio e dalle finiture raffinate. Questo kit blocchetti tendicatena sostituisce perfettamente i componenti originali. La precisione di accoppiamento con il forcellone è stata ottimizzata in modo da ridurre i giochi eccessivi, mentre le tacche di riferimento per la regolazione sono state aumentate e rese più visibili in modo da rendere più pratica e precisa la regolazione della catena. Alleggeriti in tutti i punti possibili senza precluderne l'affidabilità sono disponibili in tre colori anodizzati.

Evotech has decided to create a set of precious and refined accessories for Ktm bikes. The Chain adjuster replaces the original components without making any modifications. The match with the swingarm has been optimized and there are more dents to allow a faster and more accurate wheel alignment. It has been lightened in many points without precluding the reliability and it is available in 3 wonderful anodized colours.

**GARANZIA PRODOTTO 5 ANNI
5 YEARS PRODUCT GUARANTEE**

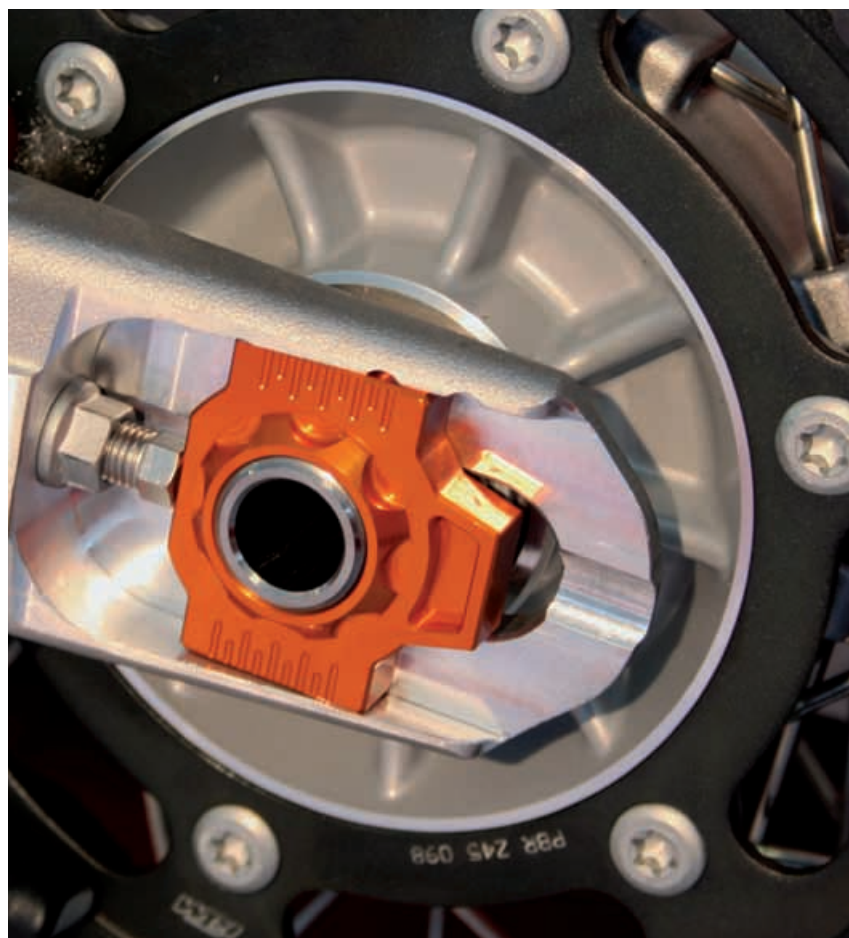

MARCA/BRAND	MODELLO/MODEL	CODICE/CODE	COLORE/COLOUR			EURO w/o tax
KTM	690 SMC	BT-0900	Si	Dn	Or	65,00
	990 Supermoto	BT-0900	Si	Dn	Or	65,00
	950 Supermoto R	BT-0900	Si	Dn	Or	65,00
	690 Duke	BT-0900	Si	Dn	Or	65,00
	990 Superduke	BT-0900	Si	Dn	Or	65,00
	990 Superduke R	BT-0900	Si	Dn	Or	65,00
	1190 RC8	BT-0900	Si	Dn	Or	65,00
	690 Supermoto	BT-0900	Si	Dn	Or	65,00
	690 Supermoto R	BT-0900	Si	Dn	Or	65,00

MARCA/BRAND	MODELLO/MODEL	CODICE/CODE	COLORE/COLOUR			EURO w/o tax
KTM	Offroad Competition SX 125/150/250/450	BT-0902	Si	Dn	Or	65,00
	Offroad Comepetition EXC 125/200/250/300/400/450/530)	BT-0902	Si	Dn	Or	65,00
	SUPERMOTO 450 SMR	BT-0902	Si	Dn	Or	65,00

THUNDERBOLT

DADI E BULLONI RUOTA ANTERIORE

FRONT WHEEL NUT

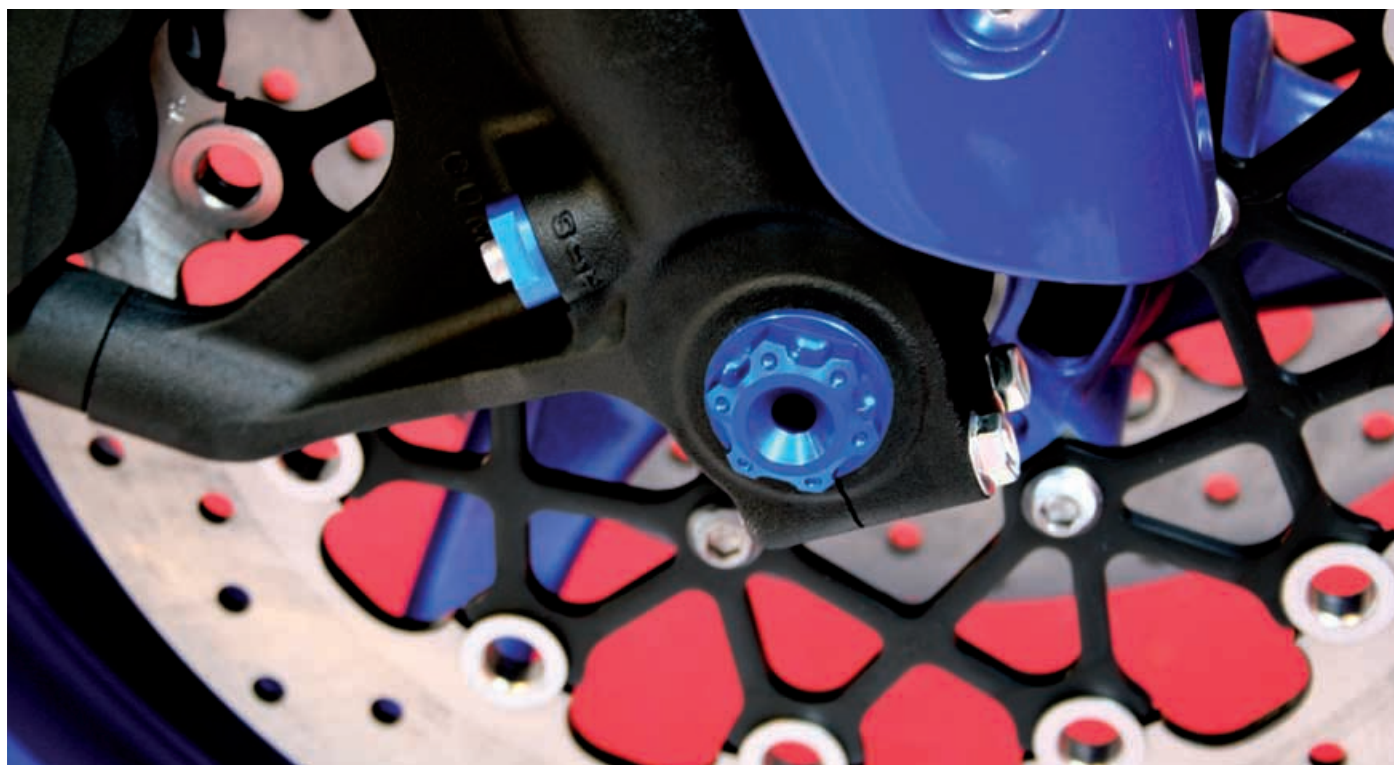
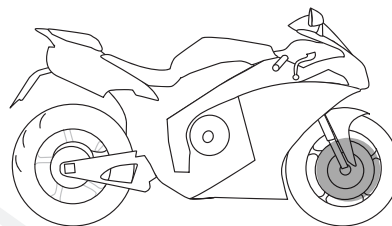

MARCA/BRAND	MODELLO/MODEL	ANNO/YEAR	CODICE/CODE	COLORE/COLOUR						EURO w/o tax
APRILIA	RSV 1000 R / Factory	'02-'08	TB-018	Si	Dn	Ti	Rg	Cr	Eb	19,50
	RSV4/TUONO R / Factory	'02-'08	TB-018	Si	Dn	Ti	Rg	Cr	Eb	19,50
	Dorsoduro / Shiver	'08-'10	TB-018	Si	Dn	Ti	Rg	Cr	Eb	19,50
	RS 125	'08-'10	TB-018	Si	Dn	Ti	Rg	Cr	Eb	19,50
HONDA	CBR 600 F / Sport	'99-'06	TB-060	Si	Dn	Ti	Rg	Cr	Eb	19,50
	CBR 600 RR	'03-'10	TB-060	Si	Dn	Ti	Rg	Cr	Eb	19,50
	HORNET 600	'98-'10	TB-060	Si	Dn	Ti	Rg	Cr	Eb	19,50
	HORNET 900	'02-'07	TB-060	Si	Dn	Ti	Rg	Cr	Eb	19,50
	CBR 1000 RR	'04-'10	TB-061	Si	Dn	Ti	Rg	Cr	Eb	19,50
	CBR 929/954 RR	'00-'03	TB-061	Si	Dn	Ti	Rg	Cr	Eb	19,50
	CB 1000 R	'08-'10	TB-060	Si	Dn	Ti	Rg	Cr	Eb	19,50
	VTR SP1/SP2	/	TB-060	Si	Dn	Ti	Rg	Cr	Eb	19,50
KAWASAKI	ZX 10R	'06-'10	TB-005	Si	Dn	Ti	Rg	Cr	Eb	19,50
SUZUKI	GSX-R 600 / 750	'06-'10	TB-061	Si	Dn	Ti	Rg	Cr	Eb	19,50
	GSX-R 1000	'05-'10	TB-061	Si	Dn	Ti	Rg	Cr	Eb	19,50
	BANDIT 1200/S	'06-'07	TB-061	Si	Dn	Ti	Rg	Cr	Eb	19,50
	B-KING	'08-'10	TB-061	Si	Dn	Ti	Rg	Cr	Eb	19,50
	HAYABUSA	'09>	TB-061	Si	Dn	Ti	Rg	Cr	Eb	19,50
YAMAHA	R6	'06-'10	TB-060	Si	Dn	Ti	Rg	Cr	Eb	19,50
	R1	'02-'10	TB-060	Si	Dn	Ti	Rg	Cr	Eb	19,50

GARANZIA PRODOTTO 5 ANNI
5 YEARS PRODUCT GUARANTEE

THUNDERBOLT

DADI RUOTA POSTERIORE

REAR WHEEL NUT

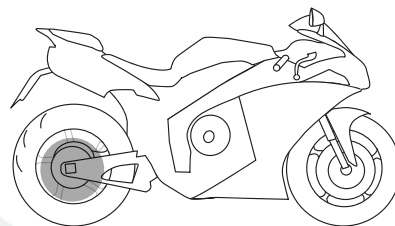

MARCA/BRAND	MODELLO/MODEL	ANNO/YEAR	CODICE/CODE	COLORE/COLOUR	EURO w/o tax
APRILIA	RSV 1000 R / RSV4	'02-'09	TB-018	Si Dn Ti Rg Cr Eb	19,50
	TUONO R / FACTORY	'02-'09	TB-018	Si Dn Ti Rg Cr Eb	19,50
	Dorsoduro/ Shiver	'08-'10	TB-018	Si Dn Ti Rg Cr Eb	19,50
BMW	S1000 RR	'10>	TB-005	Si Dn Ti Rg Cr Eb	19,50
DUCATI	749/999	'02-'06	TB-002	Si Dn Ti Rg Cr Eb	19,50
HONDA	CBR 600 F	'99-'06	TB-001	Si Dn Ti Rg Cr Eb	19,50
	HORNET 600	'98-'06	TB-017	Si Dn Ti Rg Cr Eb	19,50
	HORNET 600	'07-'10	TB-001	Si Dn Ti Rg Cr Eb	19,50
	CBR 600 RR	'03-'10	TB-003	Si Dn Ti Rg Cr Eb	19,50
	CBR 929/954 RR	'00-'03	TB-003	Si Dn Ti Rg Cr Eb	19,50
	CBR 1000 RR	'04-'10	TB-003	Si Dn Ti Rg Cr Eb	19,50
	HORNET 900	'02-'07	TB-001	Si Dn Ti Rg Cr Eb	19,50
VTR SP1- SP2	/	TB-003	Si Dn Ti Rg Cr Eb	19,50	
KAWASAKI	ZX6R/RR	'03-'10	TB-005	Si Dn Ti Rg Cr Eb	19,50
	ZX10R	'04-'10	TB-001	Si Dn Ti Rg Cr Eb	19,50
	Z1000	'03-'09	TB-005	Si Dn Ti Rg Cr Eb	19,50
	Z750/S	'04-'10	TB-001	Si Dn Ti Rg Cr Eb	19,50
	ER6-N/F - VERSYS	'06-'10	TB-001	Si Dn Ti Rg Cr Eb	19,50
SUZUKI	GSX-R 600/750	'00-'10	TB-008	Si Dn Ti Rg Cr Eb	19,50
	GSX-R 1000	'00-'10	TB-008	Si Dn Ti Rg Cr Eb	19,50
	SV650/S	'00-'09	TB-001	Si Dn Ti Rg Cr Eb	19,50
	GSR 600	'06-'10	TB-008	Si Dn Ti Rg Cr Eb	19,50
	Bandit 1200/S	'05-'08	TB-008	Si Dn Ti Rg Cr Eb	19,50
	SV 1000/S	'04-'08	TB-008	Si Dn Ti Rg Cr Eb	19,50
	Hayabusa	'99-'09	TB-008	Si Dn Ti Rg Cr Eb	19,50
B-King	'08-'09	TB-008	Si Dn Ti Rg Cr Eb	19,50	
TRIUMPH	Daytona 675 Triple	'06-'10	TB-001	Si Dn Ti Rg Cr Eb	19,50
	Street Triple	'07-'10	TB-001	Si Dn Ti Rg Cr Eb	19,50
YAMAHA	R6	'99-'10	TB-005	Si Dn Ti Rg Cr Eb	19,50
	R1	'98-'08	TB-005	Si Dn Ti Rg Cr Eb	19,50
	R1	'09-'10	TB-015	Si Dn Ti Rg Cr Eb	19,50
	Fazer 600	'98-'03	TB-001	Si Dn Ti Rg Cr Eb	19,50
	Fazer 1000	'01-'05	TB-005	Si Dn Ti Rg Cr Eb	19,50
	FZ6/ Fazer/S2	'04-'10	TB-005	Si Dn Ti Rg Cr Eb	19,50
	FZ1/ Fazer	'06-'10	TB-005	Si Dn Ti Rg Cr Eb	19,50
	MT-01	'05-'06	TB-005	Si Dn Ti Rg Cr Eb	19,50
	XJ6	'09 >	TB-017	Si Dn Ti Rg Cr Eb	19,50

THUNDERBOLT

DADI E GHIERE FORCELLONE
SWINGARM NUT

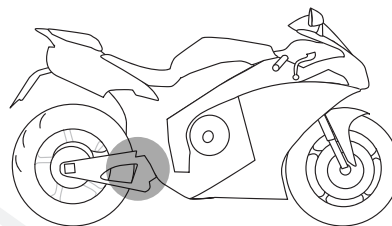

MARCA/BRAND	MODELLO/MODEL	ANNO/YEAR	CODICE/CODE	COLORE/COLOUR	EURO w/ o tax
APRILIA	Rsv 1000 / Tuono / RSV4	tutte/all	TB-002	Si Dn Ti Rg Cr Eb	19,50
	Dorsoduro / Shiver	'08-'10	TB-002	Si Dn Ti Rg Cr Eb	19,50
BMW	S1000 RR	'10>	TB-001	Si Dn Ti Rg Cr Eb	19,50
HONDA	CBR 600 F/ Sport	'99-'06	TB-001	Si Dn Ti Rg Cr Eb	19,50
	CBR 600 RR	'07-'10	TB-001	Si Dn Ti Rg Cr Eb	19,50
	HORNET 600	'98-'06	TB-016	Si Dn Ti Rg Cr Eb	19,50
	HORNET 600	'07-'10	TB-001	Si Dn Ti Rg Cr Eb	19,50
	CBR 1000 RR	'04-'10	TB-003	Si Dn Ti Rg Cr Eb	19,50
	CB 1000 R	'08-'10	TB-001	Si Dn Ti Rg Cr Eb	19,50
	VTR SP1	/	TB-003	Si Dn Ti Rg Cr Eb	19,50
VTR SP2	/	TB-001	Si Dn Ti Rg Cr Eb	19,50	
KAWASAKI	ZX6R / RR	'03-'10	TB-002	Si Dn Ti Rg Cr Eb	19,50
	ZX10R	'04-'10	TB-002	Si Dn Ti Rg Cr Eb	19,50
	Z1000	'10	TB-002	Si Dn Ti Rg Cr Eb	19,50
SUZUKI	GSX-R 600 / 750	'00-'03	TB-008	Si Dn Ti Rg Cr Eb	19,50
	GSX-R 600 / 750	'04-'10	TB-002	Si Dn Ti Rg Cr Eb	19,50
	GSX-R 1000	'01-'04	TB-008	Si Dn Ti Rg Cr Eb	19,50
	GSX-R 1000	'05-'10	TB-002	Si Dn Ti Rg Cr Eb	19,50
	SV 650 / S	'00-'09	TB-001	Si Dn Ti Rg Cr Eb	19,50
	SV 1000 / S	'04-'09	TB-008	Si Dn Ti Rg Cr Eb	19,50
	Hayabusa	'99-'10	TB-008	Si Dn Ti Rg Cr Eb	19,50
	B-king	'08-'10	TB-002	Si Dn Ti Rg Cr Eb	19,50
TRIUMPH	DAYTONA 675 Triple	'06-'10	TB-017	Si Dn Ti Rg Cr Eb	19,50
	Street Triple 675	'07-'10	TB-017	Si Dn Ti Rg Cr Eb	19,50
YAMAHA	R6	'99-'05	TB-001	Si Dn Ti Rg Cr Eb	19,50
	R6 dado sinistro / Left nut	'06-'10	TB-003	Si Dn Ti Rg Cr Eb	19,50
	R6 ghiera destra / Right ring nut	'06-'10	TB-011	Si Dn Ti Rg Cr Eb	19,50
	R1	'98-'06	TB-001	Si Dn Ti Rg Cr Eb	19,50
	R1 dado sinistro / Left nut	'07-'10	TB-002	Si Dn Ti Rg Cr Eb	19,50
	R1 ghiera destra / Right ring nut	'07-'10	TB-020	Si Dn Ti Rg Cr Eb	19,50
	Fazer 600	'98-'03	TB-001	Si Dn Ti Rg Cr Eb	19,50
	FZ6 / Faze/S2	'04-'10	TB-001	Si Dn Ti Rg Cr Eb	19,50
	FZ1 / Fazer	06-'10	TB-001	Si Dn Ti Rg Cr Eb	19,50
	MT-03	06-'10	TB-017	Si Dn Ti Rg Cr Eb	19,50

THUNDERBOLT

DADI CANOTTO DI STERZO

TOP YOKE NUT

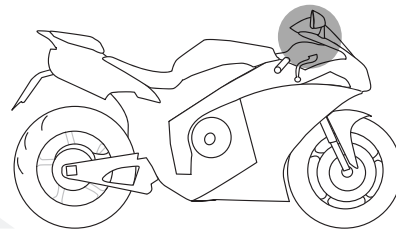

I dadi "Thunderbolt" sono ricavati dal pieno da barre di Ergal 7075 T6. Il particolare design conferisce la massima leggerezza ed un'estetica particolare. Le 6 tasche di alleggerimento sono state realizzate in un punto dove la chiave non esercita lo sforzo durante il serraggio. Abbiamo volutamente realizzato le fresature in modo da lasciare un labirinto di abbellimento sul fondo delle tasche. Si consiglia di usare solo chiavi esagonali chiuse e di utilizzare un sacchetto di nylon tra chiave e dado per non rovinarne l'anodizzazione. Il serraggio va effettuato con la stessa coppia del componente originale.

Ergal nuts machined from ergal 7075-T6 bars through sophisticated numerical control machineries. The amazing design gives a refined look to your special bike. The six pockets and the six frontal holes realized on the nut give it less weight compared to the original component. These lightening don't preclude the resistance of the product and in fact the chiselling has not been realized on the key torque point. The assembly is very easy: through a simple hexagonal key. Available in 6 anodized colours.



GARANZIA PRODOTTO 5 ANNI
5 YEARS PRODUCT GUARANTEE

MARCA/BRAND	MODELLO/MODEL	ANNO/YEAR	CODICE/CODE	COLORE/COLOUR	EURO w/o tax
APRILIA	Dorsoduro / Shiver	'08 -'09	TB-010	Si Dn Ti Rg Cr Eb	19,50
BMW	S1000 RR	'10>	TB-009	Si Dn Ti Rg Cr Eb	19,50
HONDA	CBR 600 F	'99 -'06	TB-004	Si Dn Ti Rg Cr Eb	19,50
	CBR 600 RR	'03 -'09	TB-004	Si Dn Ti Rg Cr Eb	19,50
	CBR 900 RR	'00 -'03	TB-004	Si Dn Ti Rg Cr Eb	19,50
	HORNET 600	'98 -'09	TB-004	Si Dn Ti Rg Cr Eb	19,50
	HORNET 900	'02 -'07	TB-004	Si Dn Ti Rg Cr Eb	19,50
	VTR SP1	/	TB-004	Si Dn Ti Rg Cr Eb	19,50
	CBR1000RR	'08-'10	TB-019	Si Dn Ti Rg Cr Eb	19,50
KAWASAKI	ZX 6R/RR	'05 -'10	TB-009	Si Dn Ti Rg Cr Eb	19,50
	ZX10R	'04 -'07	TB-009	Si Dn Ti Rg Cr Eb	19,50
SUZUKI	GSX-R 600 / 750	'00 -'05	TB-015	Si Dn Ti Rg Cr Eb	19,50
	GSX-R 600 / 750	'06 -'10	TB-009	Si Dn Ti Rg Cr Eb	19,50
	GSX-R 1000	'00 -'02	TB-015	Si Dn Ti Rg Cr Eb	19,50
	GSX-R 1000	'03 -'10	TB-009	Si Dn Ti Rg Cr Eb	19,50
	SV650/S	'00 -'02	TB-010	Si Dn Ti Rg Cr Eb	19,50
	SV 650/S	'03 -'08	TB-015	Si Dn Ti Rg Cr Eb	19,50
	SV 1000/S	'04 -'09	TB-015	Si Dn Ti Rg Cr Eb	19,50
	Hayabusa	tutte / all	TB-015	Si Dn Ti Rg Cr Eb	19,50
	GSR 600 Naked	'06 -'10	TB-015	Si Dn Ti Rg Cr Eb	19,50
	BANDIT 650/S	'06 -'10	TB-015	Si Dn Ti Rg Cr Eb	19,50
B-King	'08 -'10	TB-015	Si Dn Ti Rg Cr Eb	19,50	
YAMAHA	R6	'99 -'10	TB-009	Si Dn Ti Rg Cr Eb	19,50
	R1	'98 -'10	TB-009	Si Dn Ti Rg Cr Eb	19,50
	Fazer 600	'98 -'03	TB-010	Si Dn Ti Rg Cr Eb	19,50
	Fazer 1000	'01 -'05	TB-010	Si Dn Ti Rg Cr Eb	19,50
	FZ6 / Fazer	'04 -'10	TB-010	Si Dn Ti Rg Cr Eb	19,50
	FZ1 N / Fazer	'06 -'10	TB-009	Si Dn Ti Rg Cr Eb	19,50
	MT-03	'06 -'10	TB-010	Si Dn Ti Rg Cr Eb	19,50
	XJ6	'09>	TB-010	Si Dn Ti Rg Cr Eb	19,50

COVER PERNO RUOTA TMAX

WHEEL PIN COVER TMAX

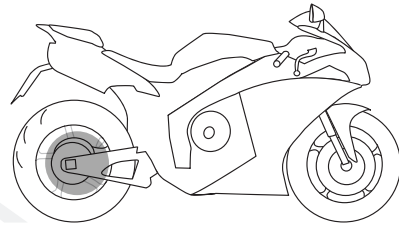

Anche su questo componente EVOTECH ha voluto mettere la propria firma, arricchendo il prodotto non solo di stile ma anche di dinamicità. Infatti sono stati realizzati due distinti particolari che ruotano uno attorno all'altro. Disponibile in 4 splendide colorazioni: blu, rosso, oro, nero. Il particolare viene fornito con scritta T Max incisa laser.

This amazing accessory shows again the elegant and dynamic Evotech style. We realized these items for Tmax scooter in four brilliant colours: blue, red, gold and black. The pin has been screen printed by laser.

GARANZIA PRODOTTO 5 ANNI
5 YEARS PRODUCT GUARANTEE



MARCA / BRAND	MODELLO / MODEL	ANNO / YEAR	CODICE / CODE	COLORE / COLOUR	EURO w/o tax
YAMAHA	T-MAX	'01 - '07	CPR-TM1	Dn Rg Cr Eb	60,00
		'08 - '10	CPR-TM2	Dn Rg Cr Eb	105,00

TAPPI OLIO OIL FILLER CAP

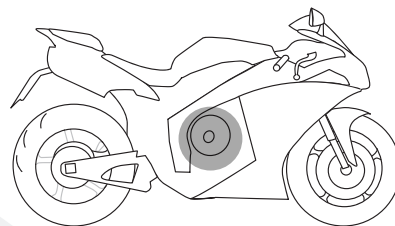

I tappi olio motore EVOTECH sono caratterizzati dallo stesso design dei dadi "Thunderbolt". Presentano inoltre dei fori radiali che permettono il fissaggio con il filo di sicurezza per le competizioni. La particolare forma evita che malintenzionati possano aprire il tappo olio a mani nude. Per la manovra è necessaria una normale chiave esagonale. Tutti i tappi olio Evotech vengono forniti con o-ring in Viton, una particolare gomma che vanta maggiore resistenza agli oli, ai vapori e alla temperatura. Garanzia prodotto 5 anni.

Evotech oil filler caps are machined from billet aluminium through sophisticated CNC machineries. The incredible design gives to specials a refined style and material makes our caps very safe and strong. We realized these accessories with an hexagonal head in order to avoid that someone can steal your oil cap. In fact it is necessary a particular key to open the cap. Some holes have been made around its shape for fixing the safety wire which is binding during competitions. The 6 milled pockets and the 6 holes give to our oil caps lightness but without precluding its resistance. Oil filler caps are available in 6 wonderful brilliant colours. 5 years product guarantee



MARCA/BRAND	PASSO/THREAD	COLORE/COLOUR						CODICE/CODE	EURO w/o tax
APRILIA	M20 x 1,5	Si	Dn	Ti	Rg	Cr	Eb	OFC-01	17,90
	Dorsoduro / Shiver / RSV4	Si	Dn	Ti	Rg	Cr	Eb	OFC-06	17,90
	RS 125	Si	Dn	Ti	Rg	Cr	Eb	OFC-10	under construction
BMW	S1000 RR	Si	Dn	Ti	Rg	Cr	Eb	OFC-11	17,90
BENELLI	M24 x 1,5	Si	Dn	Ti	Rg	Cr	Eb	OFC-02	17,90
DUCATI	M22 x 1,5	Si	Dn	Ti	Rg	Cr	Eb	OFC-03	17,90
	848*	Si	Dn	Ti	Rg	Cr	Eb	OFC-04	17,90
	Monster 696*	Si	Dn	Ti	Rg	Cr	Eb	OFC-04	17,90
	Monster 1100*	Si	Dn	Ti	Rg	Cr	Eb	OFC-04	17,90
HONDA	M20 x 2,5	Si	Dn	Ti	Rg	Cr	Eb	OFC-04	17,90
KAWASAKI	M30 x 1,5	Si	Dn	Ti	Rg	Cr	Eb	OFC-05	17,90
	ER6-N / F / Versys	Si	Dn	Ti	Rg	Cr	Eb	OFC-04	17,90
	Z1000 '10 >	Si	Dn	Ti	Rg	Cr	Eb	OFC-04	17,90
	KLV	Si	Dn	Ti	Rg	Cr	Eb	OFC-01	17,90
	KX 125 '00-'08	Si	Dn	Ti	Rg	Cr	Eb	OFC-04	17,90
KTM	M24X3	Si	Dn		Or			OFC-09	17,90
MV AGUSTA	M25 x 1,5	Si	Dn	Ti	Rg	Cr	Eb	OFC-06	17,90
SUZUKI	M20 x 1,5	Si	Dn	Ti	Rg	Cr	Eb	OFC-01	17,90
TRIUMPH	M20 X 2,5	Si	Dn	Ti	Rg	Cr	Eb	OFC-08	17,90
YAMAHA	M26 x 3	Si	Dn	Ti	Rg	Cr	Eb	OFC-07	17,90
	T-MAX M20 x 2,5	Si	Dn	Ti	Rg	Cr	Eb	OFC-04	17,90
	WR 125 / 250 '00-'08	Si	Dn	Ti	Rg	Cr	Eb	OFC-04	17,90
	WRF 250 / 450 '00-'08	Si	Dn	Ti	Rg	Cr	Eb	OFC-04	17,90
	YZ 125 / 250 '00-'08	Si	Dn	Ti	Rg	Cr	Eb	OFC-04	17,90
	YZF 250 / 450 '00-'08	Si	Dn	Ti	Rg	Cr	Eb	OFC-04	17,90

*Frizione in bagno d'olio / clutch in oil bath

SERBATOIO LIQUIDO FRENO/FRIZIONE RESERVOIR TANK

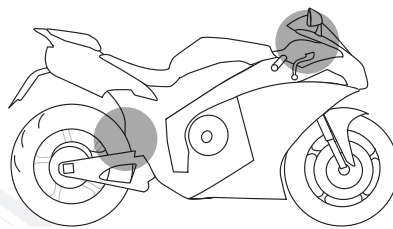

Raffinati serbatoi dedicati per un'esclusiva personalizzazione della moto, per un elegante tocco di stile. Braccetto di ancoraggio a scatto, realizzati totalmente in Alluminio Anticorrosivo. Indicatore di livello e membrana con sfiato per il recupero del volume consumato. Disponibili per l'applicazione su pompa freno anteriore, posteriore e frizione idraulica. Disponibile in 6 colori anodizzati.

Evotech elegant reservoir tank is a refined and original accessory dedicated to the personalization of your motorbike. The release system for the anchorage is completely machined from anticorrosive aluminium. There is a fluid level indicator and a venting membrane for recovering the fluid. Available for the front, rear brake pump and hydraulic clutch. Available in 6 different colours.

**GARANZIA PRODOTTO 5 ANNI
5 YEARS PRODUCT GUARANTEE**



MARCA/BRAND	COLORE/COLOUR						CODICE/CODE	EURO w/o tax
freno posteriore / rear brake	Si	Dn	Ti	Rg	Cr	Eb	RT-01	25,00
staffa / bracket	Si	Dn	Ti	Rg	Cr	Eb	RTB-UP1	10,00

CODICE/CODE	COLORE/COLOUR					
RT-01-A	Si	Dn	Ti	Rg	Cr	Eb
RT-01-C	Si	Dn	Ti	Rg	Cr	Eb

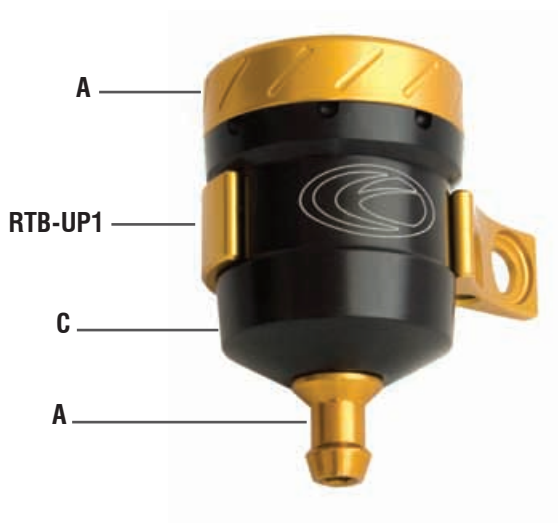

TAPPI SERBATOIO SGANCIO RAPIDO RAPID GAS CAP

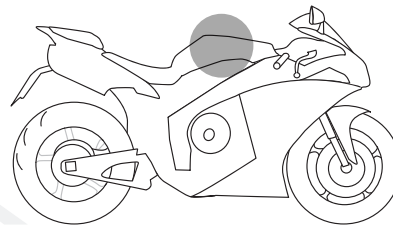

Grazie al meccanismo di apertura dei nuovi tappi serbatoio a sgancio rapido, non è mai stato così facile e veloce fare rifornimento. Basta premere la leva di manovra e girarla in senso antiorario di circa 35°. Ideale per l'uso sia su strada che in pista, il tappo a sgancio rapido EVOTECH mantiene la funzionalità dello sfiato serbatoio in modo da consentire la sua corretta respirazione senza il pericolo di perdite di carburante al suo esterno.

Thanks to the opening system of new Evotech rapid gas cap, refuelling has never been so fast and easy. Push the central lever and turn it counter-clockwise for about 35 degree. Rapid gas cap is perfect for street or racing use. The cap maintains the same fuel venting system as the original cap, avoiding any loss of fuel.

**GARANZIA PRODOTTO 5 ANNI
5 YEARS PRODUCT GUARANTEE**



MARCA/BRAND	MODELLO/MODEL	CODICE/CODE	COLORE/COLOUR	EURO w/o tax
APRILIA	RSV4 FACTORY/R '09>	FCR-A2	Si Dn Ti Rg Cr Eb /	120,00
	RSV 1000 R/Factory '04>	FCR-A2	Si Dn Ti Rg Cr Eb /	120,00
	Tuono 1000 R/Factory '06>	FCR-A2	Si Dn Ti Rg Cr Eb /	120,00
DUCATI	MONSTER 696/1100 '09	FCR-DU2	Si Dn Ti Rg Cr Eb /	120,00
	Streetfighter '09	FCR-A2	Si Dn Ti Rg Cr Eb /	120,00
	Monster 600/750/900/620/695/1000	FCR-DMY	Si Dn Ti Rg Cr Eb /	120,00
	800/S2R/S4/S4R/1098/1198/848	FCR-DMY	Si Dn Ti Rg Cr Eb /	120,00
	916/996/998/748	FCR-DMY	Si Dn Ti Rg Cr Eb /	120,00
HONDA	tutti/all	FCR-HO	Si Dn Ti Rg Cr Eb /	120,00
KAWASAKI	Z750 '07-'10	FCR-KA2	Si Dn Ti Rg Cr Eb /	120,00
	Z1000 '07-'09	FCR-KA2	Si Dn Ti Rg Cr Eb /	120,00
	ZX6R/ZX10R/ZX14R	FCR-KA2	Si Dn Ti Rg Cr Eb /	120,00
	ER6N/F '09>	FCR-KA2	Si Dn Ti Rg Cr Eb /	120,00
	ZZR 1400	FCR-KA2	Si Dn Ti Rg Cr Eb /	120,00
	VERSYS '07-'09	FCR-KA2	Si Dn Ti Rg Cr Eb /	120,00
MV AGUSTA	5 viti/5 bolts	FCR-DMY	Si Dn Ti Rg Cr Eb /	120,00
	Brutale '10	FCR-A2	Si Dn Ti Rg Cr Eb /	120,00
KTM	RC8	FCR-A2	Si Dn Ti Rg Cr Eb /	120,00
SUZUKI	Bandit GSF 1200/1250/650/S	FCR-SU2	Si Dn Ti Rg Cr Eb /	120,00
	Gladius	FCR-SU2	Si Dn Ti Rg Cr Eb /	120,00
	GSR 600	FCR-SU2	Si Dn Ti Rg Cr Eb /	120,00
	GSX-F 650 '08-'10	FCR-SU2	Si Dn Ti Rg Cr Eb /	120,00
	GSX-R 1000 '03-'10	FCR-SU2	Si Dn Ti Rg Cr Eb /	120,00
	GSX-R 1300 '08-	FCR-SU2	Si Dn Ti Rg Cr Eb /	120,00
	GSX-R 600/750 '04-'10	FCR-SU2	Si Dn Ti Rg Cr Eb /	120,00
	SV650/SV1000	FCR-SU2	Si Dn Ti Rg Cr Eb /	120,00
YAMAHA		FCR-DMY	Si Dn Ti Rg Cr Eb /	120,00
parte universale/universal inner cap		FCR-U2	Si Dn Ti Rg Cr Eb Or	/

TAPPI SERBATOIO FUEL CAP

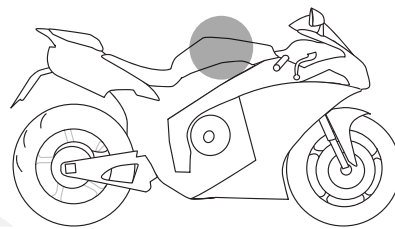

Evotech propone al pubblico un nuovo tappo serbatoio carburante esclusivo nel design e negli aspetti tecnici che lo caratterizzano. Contenuti tecnici:

- esclusivo percorso di sfianto a labirinto;
- componenti ricavati dal pezzo pieno in alluminio;
- diametro maggiorato del carico carburante, adatto a tutti i sistemi di rifornimento da pista;
- i due elementi che compongono il KIT sono disponibili in 6 tonalità di anodizzazione, andando a creare 36 combinazioni possibili; inoltre è possibile abbinare il KIT viteria in ergal avendo a disposizione 180 combinazioni. La maschera di accoppiamento al serbatoio è stata progettata per adattarsi alle diverse misure delle case costruttrici, rendendo rapida la progettazione e il collaudo. La catena di tolleranze è stata prevista tale da utilizzare come sistema di tenuta uno speciale O-RING in gomma Viton.

Once again Evotech has created a special and exclusive accessory for your bike. Technical details:

- a new and Evotech exclusive labyrinth for fuel venting
- the diameter of fuel opening is larger than OEM for quicker refueling on the track.
- the parts are CNC machined from aluminium billet
- fuel caps are available in six different colours.

You can "mix and match" the two parts (inner cap and outer mounting part) and 36 different combinations can be created. In addition you can fit also our ergal bolts kit on the tank cap getting 180 different colour combinations. The outer ring that fits on the tank has been designed to comply to the different model bikes for easy installation. We also decided to put an o-ring between the two parts in order to avoid any loss of fuel and to maintain the correct pressure.



MARCA/BRAND	MODELLO/MODEL	CODICE/CODE	COLORE/COLOUR						EURO w/o tax
APRILIA	SHIVER 750	FC-ATB	Si	Dn	Ti	Rg	Cr	Eb	80,00
	RS125 '06>	FC-ATB	Si	Dn	Ti	Rg	Cr	Eb	80,00
	RS250 '98>	FC-ATB	Si	Dn	Ti	Rg	Cr	Eb	80,00
	Tuono 1000 <'05	FC-ATB	Si	Dn	Ti	Rg	Cr	Eb	80,00
	RSV 1000 <'03	FC-ATB	Si	Dn	Ti	Rg	Cr	Eb	80,00
	RSV 1000 '04-'08	FC-A2	Si	Dn	Ti	Rg	Cr	Eb	80,00
	TUONO '05-'09	FC-A2	Si	Dn	Ti	Rg	Cr	Eb	80,00
	RSV4 /R/FACTORY	FC-A2	Si	Dn	Ti	Rg	Cr	Eb	80,00
BENELLI	TNT 899 / 1130	FC-ATB	Si	Dn	Ti	Rg	Cr	Eb	80,00
DUCATI	748/916/996/998	FC-DU	Si	Dn	Ti	Rg	Cr	Eb	80,00
	SS 620/800/900	FC-DU	Si	Dn	Ti	Rg	Cr	Eb	80,00
	PAUL SMART 1000	FC-DU	Si	Dn	Ti	Rg	Cr	Eb	80,00
	GT 1000 '07>	FC-DU	Si	Dn	Ti	Rg	Cr	Eb	80,00
	848/1098/1198	FC-DU	Si	Dn	Ti	Rg	Cr	Eb	80,00
	888 SP5	FC-DU	Si	Dn	Ti	Rg	Cr	Eb	80,00
	STREETFIGHTER	FC-A2	Si	Dn	Ti	Rg	Cr	Eb	80,00
HONDA	dal / from 2000	FC-HO	Si	Dn	Ti	Rg	Cr	Eb	80,00

TAPPI SERBATOIO FUEL CAP

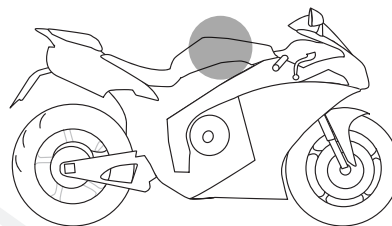

MARCA/BRAND	MODELLO/MODEL	CODICE/CODE	COLORE/COLOUR						EURO w/o tax
KAWASAKI	Z750 '04-'06	FC-KA1	Si	Dn	Ti	Rg	Cr	Eb	80,00
	Z1000 '03-'06	FC-KA1	Si	Dn	Ti	Rg	Cr	Eb	80,00
	ZX6R/RR '03-'06	FC-KA1	Si	Dn	Ti	Rg	Cr	Eb	80,00
	ZX10R '04-'05	FC-KA1	Si	Dn	Ti	Rg	Cr	Eb	80,00
	ZX9R '00-'04	FC-KA1	Si	Dn	Ti	Rg	Cr	Eb	80,00
	ER6N/F '06-'08	FC-KA1	Si	Dn	Ti	Rg	Cr	Eb	80,00
	Z750 '07-'10	FC-KA2	Si	Dn	Ti	Rg	Cr	Eb	80,00
	Z1000 '07-'09	FC-KA2	Si	Dn	Ti	Rg	Cr	Eb	80,00
	ZX6R '07-'10	FC-KA2	Si	Dn	Ti	Rg	Cr	Eb	80,00
	ZX10R '06-'10	FC-KA2	Si	Dn	Ti	Rg	Cr	Eb	80,00
	ER6N/F '09-'10	FC-KA2	Si	Dn	Ti	Rg	Cr	Eb	80,00
	ZZR 1400	FC-KA2	Si	Dn	Ti	Rg	Cr	Eb	80,00
	VERSYS '07-'09	FC-KA2	Si	Dn	Ti	Rg	Cr	Eb	80,00
	ZX14R	FC-KA2	Si	Dn	Ti	Rg	Cr	Eb	80,00
ZX250 '09>	FC-KA3	Si	Dn	Ti	Rg	Cr	Eb	80,00	
KTM	990 SUPERDUKE	FC-ATB	Si	Dn	Ti	Rg	Cr	Eb	80,00
	950 ADVENTURE	FC-ATB	Si	Dn	Ti	Rg	Cr	Eb	80,00
	990 ADVENTURE	FC-ATB	Si	Dn	Ti	Rg	Cr	Eb	80,00
	RC8	FC-A2	Si	Dn	Ti	Rg	Cr	Eb	80,00
MOTO GUZZI	GRISO	FC-ATB	Si	Dn	Ti	Rg	Cr	Eb	80,00
MV AGUSTA	Brutale '10	FC-A2	Si	Dn	Ti	Rg	Cr	Eb	80,00
SUZUKI	7 viti / 7 bolts								
	Bandit GSF 1200	FC-SU1	Si	Dn	Ti	Rg	Cr	Eb	80,00
	Bandit GSF 600/S	FC-SU1	Si	Dn	Ti	Rg	Cr	Eb	80,00
	DL 1000 V-Strom	FC-SU1	Si	Dn	Ti	Rg	Cr	Eb	80,00
	DL 650 V-Strom	FC-SU1	Si	Dn	Ti	Rg	Cr	Eb	80,00
	GS 500 '01-	FC-SU1	Si	Dn	Ti	Rg	Cr	Eb	80,00
	GSX 1400	FC-SU1	Si	Dn	Ti	Rg	Cr	Eb	80,00
	GSX 750 F '98-	FC-SU1	Si	Dn	Ti	Rg	Cr	Eb	80,00
	GSX 750 Naked	FC-SU1	Si	Dn	Ti	Rg	Cr	Eb	80,00
	GSX F 600 '97-'00	FC-SU1	Si	Dn	Ti	Rg	Cr	Eb	80,00
	GSX-F 750 F '98>	FC-SU1	Si	Dn	Ti	Rg	Cr	Eb	80,00
	GSX R 1000 '01-'02	FC-SU1	Si	Dn	Ti	Rg	Cr	Eb	80,00
	GSX R 1100 '91-'97	FC-SU1	Si	Dn	Ti	Rg	Cr	Eb	80,00
	GSX R 1300 Hayabusa-'07	FC-SU1	Si	Dn	Ti	Rg	Cr	Eb	80,00
	GSX R 600 '97-'03	FC-SU1	Si	Dn	Ti	Rg	Cr	Eb	80,00
	GSX R 750 '92-'03	FC-SU1	Si	Dn	Ti	Rg	Cr	Eb	80,00
	RF 600	FC-SU1	Si	Dn	Ti	Rg	Cr	Eb	80,00
	RF 900 '94-'97	FC-SU1	Si	Dn	Ti	Rg	Cr	Eb	80,00
	SV 650/S '02	FC-SU1	Si	Dn	Ti	Rg	Cr	Eb	80,00
	TL 1000 R/S	FC-SU1	Si	Dn	Ti	Rg	Cr	Eb	80,00
	XF 650 Freewind	FC-SU1	Si	Dn	Ti	Rg	Cr	Eb	80,00
	5 viti / 5 bolts								
	Bandit GSF 1200/1250	FC-SU2	Si	Dn	Ti	Rg	Cr	Eb	80,00
	Bandit GSF 650/S '05-'07	FC-SU2	Si	Dn	Ti	Rg	Cr	Eb	80,00
	Gladius	FC-SU2	Si	Dn	Ti	Rg	Cr	Eb	80,00
	GSR 600	FC-SU2	Si	Dn	Ti	Rg	Cr	Eb	80,00
GSX F 650'08-'10	FC-SU2	Si	Dn	Ti	Rg	Cr	Eb	80,00	
GSX R 1000 '03-'10	FC-SU2	Si	Dn	Ti	Rg	Cr	Eb	80,00	

TAPPI SERBATOIO FUEL CAP

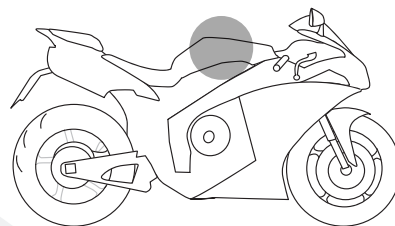

MARCA/BRAND	MODELLO/MODEL	CODICE/CODE	COLORE/COLOUR						EURO w/o tax
SUZUKI	GSX R 1300 '08-'10	FC-SU2	Si	Dn	Ti	Rg	Cr	Eb	80,00
	GSX R 600/750 '04-'10	FC-SU2	Si	Dn	Ti	Rg	Cr	Eb	80,00
	SV 1000	FC-SU2	Si	Dn	Ti	Rg	Cr	Eb	80,00
	SV 650/S '03-'09	FC-SU2	Si	Dn	Ti	Rg	Cr	Eb	80,00
TRIUMPH	SPEED TRIPLE 1050	FC-ATB	Si	Dn	Ti	Rg	Cr	Eb	80,00
	DAYTONA 955i	FC-ATB	Si	Dn	Ti	Rg	Cr	Eb	80,00
	DAYTONA T955 '02-'04	FC-ATB	Si	Dn	Ti	Rg	Cr	Eb	80,00
	SPEED TRIPLE T955 '02-'04	FC-ATB	Si	Dn	Ti	Rg	Cr	Eb	80,00
	STREET TRIPLE	FC-ATB	Si	Dn	Ti	Rg	Cr	Eb	80,00
	DAYTONA 675	FC-ATB	Si	Dn	Ti	Rg	Cr	Eb	80,00
YAMAHA	Fazer 600 '03	FC-YA	Si	Dn	Ti	Rg	Cr	Eb	80,00
	FZ6/FZ6 S2	FC-YA	Si	Dn	Ti	Rg	Cr	Eb	80,00
	MT-03	FC-YA	Si	Dn	Ti	Rg	Cr	Eb	80,00
	Thundercat 600	FC-YA	Si	Dn	Ti	Rg	Cr	Eb	80,00
	R6 '99-'10	FC-YA	Si	Dn	Ti	Rg	Cr	Eb	80,00
	YZF 750 '93-'98	FC-YA	Si	Dn	Ti	Rg	Cr	Eb	80,00
	Thunderace 1000	FC-YA	Si	Dn	Ti	Rg	Cr	Eb	80,00
	R1 '00-'10	FC-YA	Si	Dn	Ti	Rg	Cr	Eb	80,00
	FZ1/Fazer 1000 '05-'10	FC-YA	Si	Dn	Ti	Rg	Cr	Eb	80,00
	FZ1 Naked '06-'10	FC-YA	Si	Dn	Ti	Rg	Cr	Eb	80,00
	Bulldog	FC-YA	Si	Dn	Ti	Rg	Cr	Eb	80,00
	MT-01	FC-YA	Si	Dn	Ti	Rg	Cr	Eb	80,00
	TDM 850 '91-'01	FC-YA	Si	Dn	Ti	Rg	Cr	Eb	80,00
	TDM 900	FC-YA	Si	Dn	Ti	Rg	Cr	Eb	80,00
	XJR 1300	FC-YA	Si	Dn	Ti	Rg	Cr	Eb	80,00
parte universale / universal inner cap		FC-U	Si	Dn	Ti	Rg	Cr	Eb	/

GARANZIA PRODOTTO 5 ANNI
5 YEARS PRODUCT GUARANTEE

KIT VITI SERBATOIO FUEL CAP BOLTS KIT

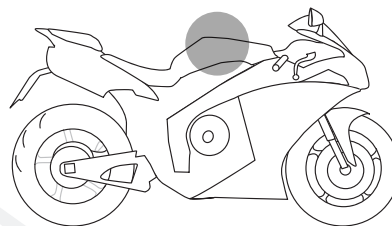

MARCA/BRAND	MODELLO/MODEL	ANNO/YEAR	CODICE/CODE	COLORE/COLOUR	EURO w/o tax
APRILIA	RS 125	'97-'00	KVS-003	Si Dn Rg Cr Eb	9,40
	RS 250 Replica	'99-	KVS-005	Si Dn Rg Cr Eb	7,70
	SL FALCO 1000		KVS-005	Si Dn Rg Cr Eb	7,70
	TUONO	'02-'05	KVS-004	Si Dn Rg Cr Eb	7,95
	TUONO	'06-'09	KVS-004	Si Dn Rg Cr Eb	7,95
	RSV 1000/R/Factory	98-'09	KVS-004	Si Dn Rg Cr Eb	7,95
	SHIVER 750	07-'10	KVS-004	Si Dn Rg Cr Eb	7,95
BENELLI	TnT 1130/899	/	KVS-004	Si Dn Rg Cr Eb	7,95
	TRE 1130 K	/	KVS-004	Si Dn Rg Cr Eb	7,95
BMW	F 650 Enduro	'93-'99	KVS-007	Si Dn Rg Cr Eb	8,40
	R 1100 RT	'95-'00	KVS-007	Si Dn Rg Cr Eb	8,40
	R 1150 RT	'01-'05	KVS-007	Si Dn Rg Cr Eb	8,40
	R 1150 GS/Adventure	'99-	KVS-007	Si Dn Rg Cr Eb	8,40
	R 1200 CL	'02-	KVS-007	Si Dn Rg Cr Eb	8,40
	R 1100 RS	'98-'03	KVS-007	Si Dn Rg Cr Eb	8,40
	K 1200 RS	'97-'00	KVS-007	Si Dn Rg Cr Eb	8,40
	K 1200 RS	'01-'05	KVS-007	Si Dn Rg Cr Eb	8,40
	K 1200 R	'05-	KVS-007	Si Dn Rg Cr Eb	8,40
K 1200 GT	'06-	KVS-007	Si Dn Rg Cr Eb	8,40	
DUCATI	748/916/996/749/999	/	KVS-012	Si Dn Rg Cr Eb	6,50
	MONSTER DS 1000	'03-'09	KVS-012	Si Dn Rg Cr Eb	6,50
	848/1098/1198	/	KVS-012	Si Dn Rg Cr Eb	6,50
	MONSTER 696/1100	'08-'09	KVS-040	Si Dn Rg Cr Eb	14,30
	ST2/ST4	/	KVS-013	Si Dn Rg Cr Eb	9,90
HONDA	CBR 600	'00	KVS-014	Si Dn Rg Cr Eb	8,50
	CBR 600 F/Sport	'01-'02	KVS-015	Si Dn Rg Cr Eb	8,50
	CBR 900 RR	'96-'99	KVS-014	Si Dn Rg Cr Eb	8,50
	VFR 750	'90-'97	KVS-014	Si Dn Rg Cr Eb	8,50
	VFR 800	'98-	KVS-014	Si Dn Rg Cr Eb	8,50
	VTR 1000 F	/	KVS-014	Si Dn Rg Cr Eb	8,50
	X 11	/	KVS-014	Si Dn Rg Cr Eb	8,50
	CBR 1100 XX	/	KVS-014	Si Dn Rg Cr Eb	8,50
	CB 1300	/	KVS-015	Si Dn Rg Cr Eb	8,50
	VTR SP1	'00-'01	KVS-014	Si Dn Rg Cr Eb	8,50
	VTR SP2	'02	KVS-015	Si Dn Rg Cr Eb	8,50
	CBR 600 RR	'03-'10	KVS-015	Si Dn Rg Cr Eb	8,50
	HORNET 600	'03-'10	KVS-015	Si Dn Rg Cr Eb	8,50
	HORNET 900	'03-'07	KVS-015	Si Dn Rg Cr Eb	8,50
	CB 1000 R	'08-'10	KVS-015	Si Dn Rg Cr Eb	8,50
	CBR 929 RR	'00-'01	KVS-014	Si Dn Rg Cr Eb	8,50
	CBR 954 RR	'02-'03	KVS-015	Si Dn Rg Cr Eb	8,50
CBR 1000 RR	'04-'10	KVS-015	Si Dn Rg Cr Eb	8,50	
MV AGUSTA	F4 750/1000	5 viti/5 bolts	KVS-012	Si Dn Rg Cr Eb	6,50
	BRUTALE	5 viti/5 bolts	KVS-012	Si Dn Rg Cr Eb	6,50
KAWASAKI	ZX250 Ninja	'08-'10	KVS-027	Si Dn Rg Cr Eb	7,20
	ZX6R	'00-'02	KVS-041	Si Dn Rg Cr Eb	6,00
	ZX6R/RR	'03-'06	KVS-041	Si Dn Rg Cr Eb	6,00
	ZX6R	'07-'10	KVS-017	Si Dn Rg Cr Eb	6,00

KIT VITI SERBATOIO FUEL CAP BOLTS KIT

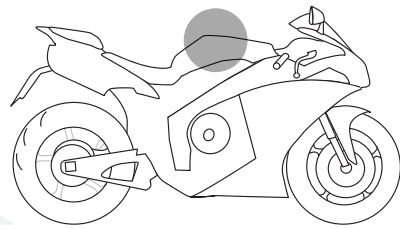

MARCA/BRAND	MODELLO/MODEL	ANNO/YEAR	CODICE/CODE	COLORE/COLOUR	EURO w/o tax
KAWASAKI	ER6-N/F	'06-'10	KVS-017	Si Dn Rg Cr Eb	5,90
	VERSYS	'07-'10	KVS-017	Si Dn Rg Cr Eb	5,90
	ZX7R	/	KVS-019	Si Dn Rg Cr Eb	8,19
	ZX9R	'98-'99	KVS-019	Si Dn Rg Cr Eb	8,19
	ZX9R	'00-'04	KVS-041	Si Dn Rg Cr Eb	6,00
	ZX10R	'04-'10	KVS-017	Si Dn Rg Cr Eb	5,90
	Z 750	'04-'10	KVS-017	Si Dn Rg Cr Eb	5,90
	Z 1000	'03-'09	KVS-017	Si Dn Rg Cr Eb	5,90
	ZX12R	/	KVS-018	Si Dn Rg Cr Eb	4,70
SUZUKI	SV 650/S	'03-'09	KVS-026	Si Dn Rg Cr Eb	6,17
	SV 1000/S	'03-'09	KVS-026	Si Dn Rg Cr Eb	6,17
	FREEWIND 650	/	KVS-023	Si Dn Rg Cr Eb	8,97
	GSR 600	'06-'10	KVS-026	Si Dn Rg Cr Eb	6,17
	GSX-R 600	'97-'03	KVS-022	Si Dn Rg Cr Eb	8,67
	GSX-R 750	'00-'03	KVS-022	Si Dn Rg Cr Eb	8,67
	GSX-R 600/750	'04-'10	KVS-026	Si Dn Rg Cr Eb	6,17
	GSX-R 1000	'01-'02	KVS-022	Si Dn Rg Cr Eb	8,67
	GSX-R 1000	'03-'04	KVS-026	Si Dn Rg Cr Eb	6,17
	GSX-R 1000	'05-'10	KVS-026	Si Dn Rg Cr Eb	6,17
	GSF 1200 Bandit	/	KVS-028	Si Dn Rg Cr Eb	9,80
	GSX-R 1300 Hayabusa	'99-'07	KVS-022	Si Dn Rg Cr Eb	8,67
	GSX-R 1300 Hayabusa	'08-'10	KVS-026	Si Dn Rg Cr Eb	6,17
KTM	Superduke 990	'05-'09	KVS-020	Si Dn Rg Cr Eb	7,65
TRIUMPH	TT 600	/	KVS-029	Si Dn Rg Cr Eb	7,80
	SPRINT	/	KVS-029	Si Dn Rg Cr Eb	7,80
	SPEED TRIPLE	'97-'10	KVS-029	Si Dn Rg Cr Eb	7,80
	DAYTONA 675	'06-'10	KVS-029	Si Dn Rg Cr Eb	7,80
	STREET TRIPLE	'07-'10	KVS-009	Si Dn Rg Cr Eb	8,10
	DAYTONA 955 i	'02-'05	KVS-009	Si Dn Rg Cr Eb	8,10
YAMAHA	FZR 400/600	/	KVS-033	Si Dn Rg Cr Eb	10,41
	Fazer 600	'97-'03	KVS-024	Si Dn Rg Cr Eb	8,50
	Fazer 1000	'99-'05	KVS-024	Si Dn Rg Cr Eb	8,50
	FZ6/Fazer/S2	'04-'10	KVS-036	Si Dn Rg Cr Eb	6,10
	R6	'99-'02	KVS-012	Si Dn Rg Cr Eb	6,50
	R6	'05-'10	KVS-042	Si Dn Rg Cr Eb	6,40
	MT-03	'06-'10	KVS-042	Si Dn Rg Cr Eb	6,40
	XJ6	'09-'10	KVS-042	Si Dn Rg Cr Eb	6,40
	TDM 850	'91-'95	KVS-034	Si Dn Rg Cr Eb	8,58
	TDM 850	'96-'01	KVS-035	Si Dn Rg Cr Eb	8,50
	TDM 900	'02-'10	KVS-024	Si Dn Rg Cr Eb	8,50
	R1	'98-'01	KVS-024	Si Dn Rg Cr Eb	8,50
	R1	'02-'03	KVS-036	Si Dn Rg Cr Eb	6,10
	R1	'04-'10	KVS-042	Si Dn Rg Cr Eb	6,40
	FZ1 Naked/Fazer	'06-'10	KVS-042	Si Dn Rg Cr Eb	6,40
	BT Bulldog 1100	'02-'06	KVS-010	Si Dn Rg Cr Eb	7,94
	XVS 1100 Dragstar	'99-'02	KVS-037	Si Dn Rg Cr Eb	3,51

**GARANZIA PRODOTTO 5 ANNI
5 YEARS PRODUCT GUARANTEE**

KIT VITI CUPOLINO SCREEN BOLTS KIT

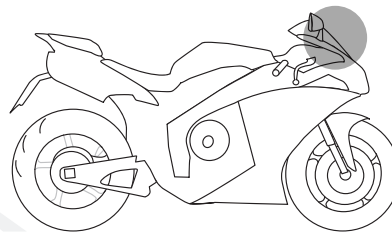

MARCA/BRAND	MODELLO/MODEL	ANNO/YEAR	CODICE/CODE	COLORE/COLOUR	EURO w/o tax
APRILIA	RS 125	'06-'10	KVC-032	Si Dn Rg Cr Eb	16,60
	RS 250	'99-	KVC-030	Si Dn Rg Cr Eb	7,00
	TUONO	'03-'05	KVC-001	Si Dn Rg Cr Eb	14,20
	RSV 1000	'01-'03	KVC-002	Si Dn Rg Cr Eb	13,60
	RSV 1000/R/Factory	'04-'05	KVC-003	Si Dn Rg Cr Eb	12,40
	SHIVER 750	'07-'10	KVC-029	Si Dn Rg Cr Eb	6,80
BMW	S 1000 RR	'10	KVC-034	Si Dn Rg Cr Eb	13,20
DUCATI	748/916/996/749/999	/	KVC-004	Si Dn Rg Cr Eb	14,40
	MONSTER S4	'01-'02	KVC-005	Si Dn Rg Cr Eb	6,90
	MONSTER DS 1000	'03-	KVC-006	Si Dn Rg Cr Eb	21,10
	998	/	KVC-018	Si Dn Rg Cr Eb	18,30
HONDA	CBR 600 RR	'03-'06	KVC-008	Si Dn Rg Cr Eb	9,90
	CBR 600 RR	'07-	KVC-015	Si Dn Rg Cr Eb	13,30
	CBR 900 RR	'97-'99	KVC-008	Si Dn Rg Cr Eb	9,90
	CBR 600 F/S	'01-'06	KVC-008	Si Dn Rg Cr Eb	9,90
	VTR SP1/SP2	'00-'03	KVC-008	Si Dn Rg Cr Eb	9,90
	CBR 929 RR	'00-'01	KVC-009	Si Dn Rg Cr Eb	9,90
	CBR 954 RR	'02-'03	KVC-010	Si Dn Rg Cr Eb	21,45
	CBR 1000 RR	'04-'07	KVC-008	Si Dn Rg Cr Eb	9,90
	CBR 1000 RR	'08-'10	KVC-016	Si Dn Rg Cr Eb	6,60
MV AGUSTA	F4 750/1000	/	KVC-013	Si Dn Rg Cr Eb	16,50
KAWASAKI	ZX6R	'00-'02	KVC-008	Si Dn Rg Cr Eb	9,90
	ZX6R/RR	'03-'04	KVC-015	Si Dn Rg Cr Eb	13,30
	ZX6R	'05-'08	KVC-008	Si Dn Rg Cr Eb	9,90
	ZX6R	'09-'10	KVC-023	Si Dn Rg Cr Eb	15,50
	ZX9R	'00-'03	KVC-008	Si Dn Rg Cr Eb	9,90

KIT VITI CUPOLINO SCREEN BOLTS KIT

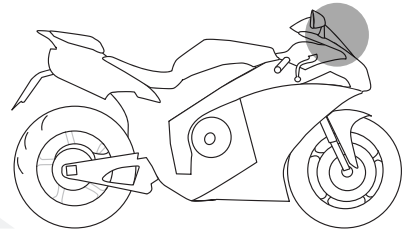

MARCA/BRAND	MODELLO/MODEL	ANNO/YEAR	CODICE/CODE	COLORE/COLOUR	EURO w/o tax
KAWASAKI	ZX10R	'04-'10	KVC-008	\$i Dn Rg Cr Eb	9,90
	ZX12R	'00-	KVC-008	\$i Dn Rg Cr Eb	9,90
	Z 1000	'03-'06	KVC-016	\$i Dn Rg Cr Eb	6,60
KTM	SUPER DUKE 990	'07-'10	KVC-016	\$i Dn Rg Cr Eb	6,60
	990 SUPERMOTO T		KVC-033	\$i Dn Rg Cr Eb	16,60
SUZUKI	GSX-R 600 / 750	'04-'05	KVC-016	\$i Dn Rg Cr Eb	6,60
	GSX-R 600 / 750	'06-'10	KVC-024	\$i Dn Rg Cr Eb	10,00
	GSX-R 1000	'05-'10	KVC-008	\$i Dn Rg Cr Eb	9,90
YAMAHA	Fazer 600	'99-'03	KVC-026	\$i Dn Rg Cr Eb	13,60
	FZ6 Fazer	'04-	KVC-025	\$i Dn Rg Cr Eb	10,70
	Fazer 1000	'99-'05	KVC-026	\$i Dn Rg Cr Eb	13,60
	XJ6	'09-'10	KVC-030	\$i Dn Rg Cr Eb	7,00
	R6	'99-'00	KVC-016	\$i Dn Rg Cr Eb	6,60
	R6	'03-'10	KVC-016	\$i Dn Rg Cr Eb	6,60
	R1	'98-'06	KVC-008	\$i Dn Rg Cr Eb	9,90
	FZ1 Naked	'06-'10	KVC-031	\$i Dn Rg Cr Eb	9,20

**GARANZIA PRODOTTO 5 ANNI
5 YEARS PRODUCT GUARANTEE**

VITERIA IN ERGAL ERGAL BOLTS

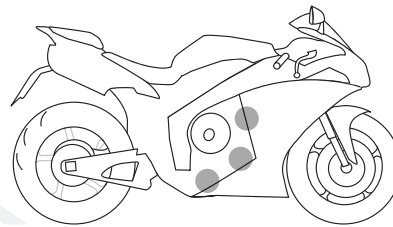

Ricavata da barre in Ergal 7075 T6 mediante lavorazione dal pieno con macchine CNC. Grazie al materiale e alle tecniche di lavorazione impiegate queste viti pesano meno di un terzo delle viti in acciaio. Disponibili in 5 colori anodizzati. La viteria in Ergal è indicata per il fissaggio di parti NON STRUTTURALI (parafanghi, carenatura, cupolino, telaio anteriore, bracciale frizione, paratacchi delle pedane, coperchi laterali motore, serbatoi olio freno, tappo serbatoio, staffe varie, supporto silenziatore).

Machined from Ergal 7075 T6 bars through CNC machineries. Thanks to material and machining technologies these bolts weight less than 60% compared to the steel bolts. They are available in 5 anodized colours. Ergal is suitable to use in ALL NON-SAFETY CRITICAL AREAS e.g. mudguards, screens, fairings, engine casings, huggers, fuel caps, fuel cap surround, number plates, lamp units, exhaust cans, heel plates, clutch levers, exhaust manifold brackets and so on.

GARANZIA PRODOTTO 5 ANNI
5 YEARS PRODUCT GUARANTEE

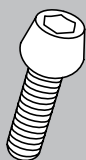

TCCE

CODICE/CODE	MODELLO/MODEL	COLORE/COLOUR	EURO w/o tax
TCCE	M5X10	Si Dn Rg Cr Eb	1,15
TCCE	M5X15	Si Dn Rg Cr Eb	1,20
TCCE	M5X20	Si Dn Rg Cr Eb	1,30
TCCE	M5X25	Si Dn Rg Cr Eb	1,40
TCCE	M5X30	Si Dn Rg Cr Eb	1,45
TCCE	M5X35	Si Dn Rg Cr Eb	1,50
TCCE	M6X10	Si Dn Rg Cr Eb	1,15
TCCE	M6X15	Si Dn Rg Cr Eb	1,20
TCCE	M6X20	Si Dn Rg Cr Eb	1,30
TCCE	M6X25	Si Dn Rg Cr Eb	1,40
TCCE	M6X30	Si Dn Rg Cr Eb	1,45
TCCE	M6X35	Si Dn Rg Cr Eb	1,50
TCCE	M6X40	Si Dn Rg Cr Eb	1,55
TCCE	M6X45	Si Dn Rg Cr Eb	1,65
TCCE	M6X50	Si Dn Rg Cr Eb	1,70
TCCE	M6X55	Si Dn Rg Cr Eb	1,85
TCCE	M6X60	Si Dn Rg Cr Eb	1,95
TCCE	M6X65	Si Dn Rg Cr Eb	2,05
TCCE	M6X70	Si Dn Rg Cr Eb	2,15
TCCE	M6X75	Si Dn Rg Cr Eb	2,30
TCCE	M6X80	Si Dn Rg Cr Eb	2,35
TCCE	M6X85	Si Dn Rg Cr Eb	2,40
TCCE	M6X90	Si Dn Rg Cr Eb	2,50
TCCE	M6X95	Si Dn Rg Cr Eb	2,70
TCCE	M6X100	Si Dn Rg Cr Eb	2,80
TCCE	M8X10	Si Dn Rg Cr Eb	1,40
TCCE	M8X15	Si Dn Rg Cr Eb	1,50
TCCE	M8X20	Si Dn Rg Cr Eb	1,55
TCCE	M8X25	Si Dn Rg Cr Eb	1,65
TCCE	M8X30	Si Dn Rg Cr Eb	1,70
TCCE	M8X35	Si Dn Rg Cr Eb	1,80
TCCE	M8X40	Si Dn Rg Cr Eb	1,85
TCCE	M8X45	Si Dn Rg Cr Eb	1,90
TCCE	M8X50	Si Dn Rg Cr Eb	2,00
TCCE	M8X55	Si Dn Rg Cr Eb	2,10
TCCE	M8X60	Si Dn Rg Cr Eb	2,20

VITERIA IN ERGAL ERGAL BOLTS

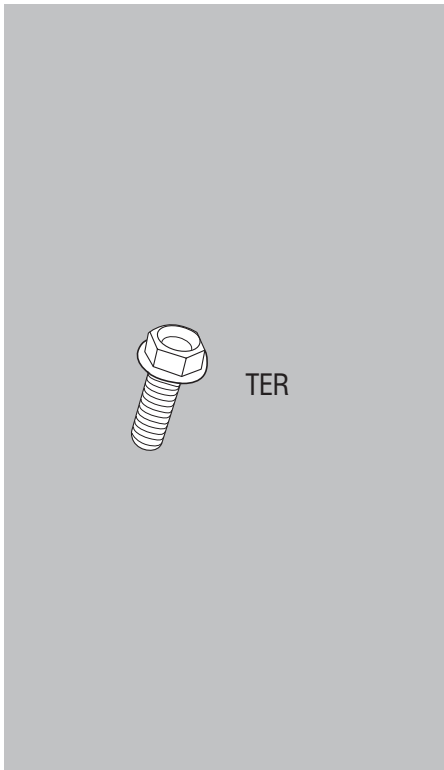
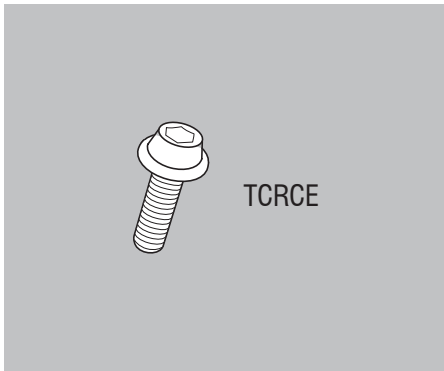
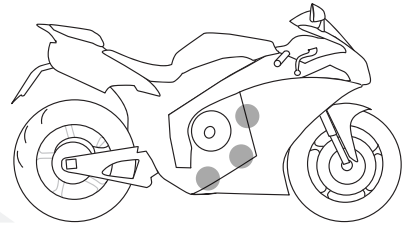

CODICE/CODE	MODELLO/MODEL	COLORE/COLOUR	EURO w/o tax
TCRCE	M6X10	Si Dn Rg Cr Eb	1,30
TCRCE	M6X15	Si Dn Rg Cr Eb	1,35
TCRCE	M6X20	Si Dn Rg Cr Eb	1,40
TCRCE	M6X25	Si Dn Rg Cr Eb	1,50
TCRCE	M6X30	Si Dn Rg Cr Eb	1,60
TCRCE	M6X35	Si Dn Rg Cr Eb	1,65
TCRCE	M6X40	Si Dn Rg Cr Eb	1,70
TCRCE	M8X35	Si Dn Rg Cr Eb	2,50
TCRCE	M8X40	Si Dn Rg Cr Eb	2,60
TCRCE	M8X45	Si Dn Rg Cr Eb	2,70
TCRCE	M8X50	Si Dn Rg Cr Eb	2,80
TCRCE	M8X55	Si Dn Rg Cr Eb	3,00
TER	M5X10	Si Dn Rg Cr Eb	1,60
TER	M5X15	Si Dn Rg Cr Eb	1,65
TER	M5X20	Si Dn Rg Cr Eb	1,70
TER	M5X25	Si Dn Rg Cr Eb	1,75
TER	M5X30	Si Dn Rg Cr Eb	1,80
TER	M5X35	Si Dn Rg Cr Eb	1,90
TER	M6X10	Si Dn Rg Cr Eb	1,75
TER	M6X15	Si Dn Rg Cr Eb	1,80
TER	M6X20	Si Dn Rg Cr Eb	1,90
TER	M6X25	Si Dn Rg Cr Eb	1,95
TER	M6X30	Si Dn Rg Cr Eb	2,00
TER	M6X35	Si Dn Rg Cr Eb	2,05
TER	M6X40	Si Dn Rg Cr Eb	2,15
TER	M6X45	Si Dn Rg Cr Eb	2,30
TER	M6X50	Si Dn Rg Cr Eb	2,35
TER	M6X55	Si Dn Rg Cr Eb	2,50
TER	M6X60	Si Dn Rg Cr Eb	2,60
TER	M6X65	Si Dn Rg Cr Eb	2,70
TER	M6X70	Si Dn Rg Cr Eb	2,80
TER	M6X75	Si Dn Rg Cr Eb	2,90
TER	M6X80	Si Dn Rg Cr Eb	3,00
TER	M6X85	Si Dn Rg Cr Eb	3,10
TER	M6X90	Si Dn Rg Cr Eb	3,20
TER	M6X95	Si Dn Rg Cr Eb	3,30
TER	M6X100	Si Dn Rg Cr Eb	3,50

VITERIA IN ERGAL ERGAL BOLTS

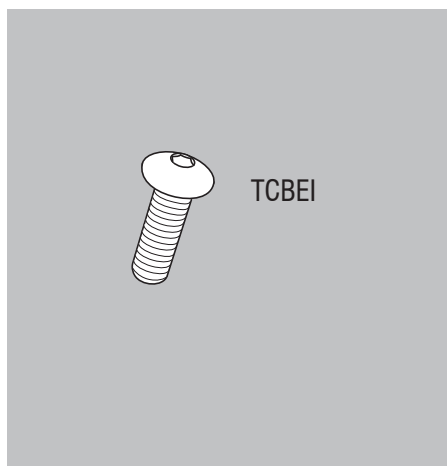
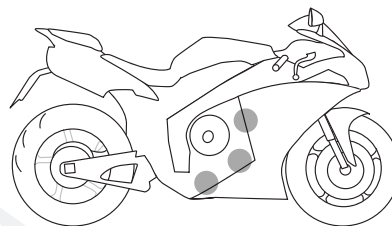

CODICE/CODE	MODELLO/MODEL	COLORE/COLOUR	EURO w/o tax
TCBEI	M4X10	Dn Si Rg Cr Eb	1,55
TCBEI	M4X15	Dn Si Rg Cr Eb	1,65
TCBEI	M5X10	Dn Si Rg Cr Eb	1,55
TCBEI	M5X15	Dn Si Rg Cr Eb	1,65
TCBEI	M5X20	Dn Si Rg Cr Eb	1,70
TCBEI	M5X25	Dn Si Rg Cr Eb	1,80
TCBEI	M5X30	Dn Si Rg Cr Eb	1,90
TCBEI	M6X10	Dn Si Rg Cr Eb	1,70
TCBEI	M6X15	Dn Si Rg Cr Eb	1,75
TCBEI	M6X20	Dn Si Rg Cr Eb	1,80
TCBEI	M6X25	Dn Si Rg Cr Eb	1,85
TCBEI	M6X30	Dn Si Rg Cr Eb	1,90
TCBEI	M6X35	Dn Si Rg Cr Eb	2,00
TCBEI	M6X40	Dn Si Rg Cr Eb	2,10
TCBEI	M6X45	Dn Si Rg Cr Eb	2,40

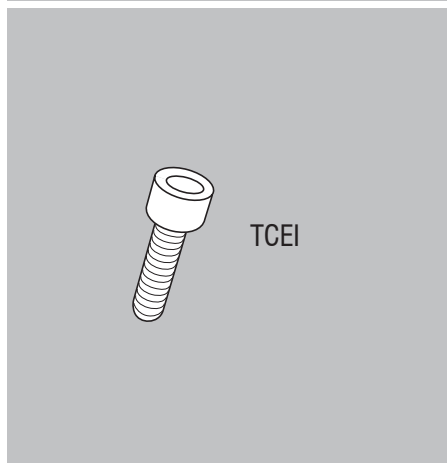

TCEI	M5X8	Dn Si Rg Cr Eb	1,10
TCEI	M5X10	Dn Si Rg Cr Eb	1,15
TCEI	M5X12	Dn Si Rg Cr Eb	1,17
TCEI	M5X15	Dn Si Rg Cr Eb	1,20
TCEI	M5X20	Dn Si Rg Cr Eb	1,30
TCEI	M5X25	Dn Si Rg Cr Eb	1,40
TCEI	M5X30	Dn Si Rg Cr Eb	1,45
TCEI	M6X8	Dn Si Rg Cr Eb	1,10
TCEI	M6X10	Dn Si Rg Cr Eb	1,15
TCEI	M6X12	Dn Si Rg Cr Eb	1,17
TCEI	M6X15	Dn Si Rg Cr Eb	1,20
TCEI	M6X20	Dn Si Rg Cr Eb	1,30
TCEI	M6X25	Dn Si Rg Cr Eb	1,40
TCEI	M6X30	Dn Si Rg Cr Eb	1,45
TCEI	M6X35	Dn Si Rg Cr Eb	1,50

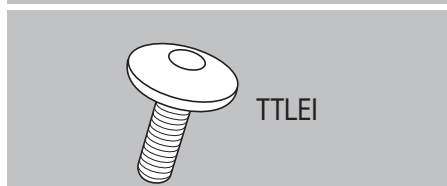

TTLEI	M5X10	Dn Si Rg Cr Eb	1,55
TTLEI	M5X15	Dn Si Rg Cr Eb	1,65
TTLEI	M5X20	Dn Si Rg Cr Eb	1,70
TTLEI	M6X10	Dn Si Rg Cr Eb	1,80
TTLEI	M6X15	Dn Si Rg Cr Eb	1,85
TTLEI	M6X20	Dn Si Rg Cr Eb	1,98

VITERIA IN ERGAL ERGAL BOLTS

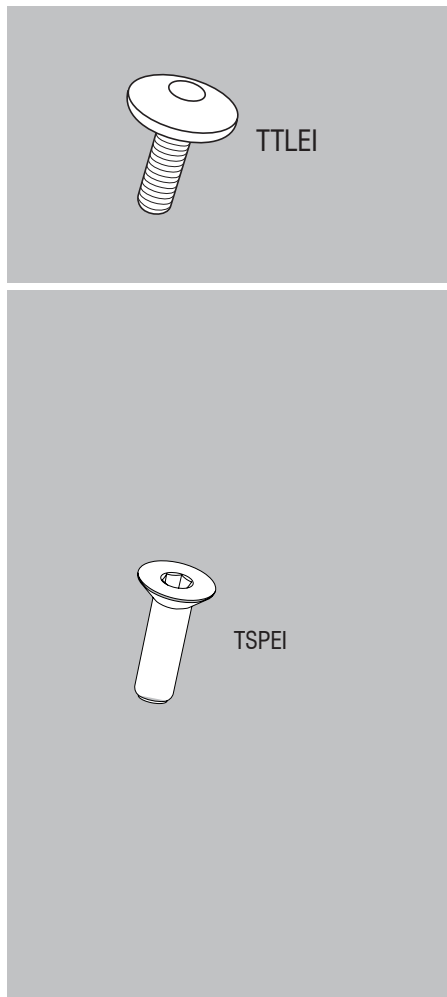
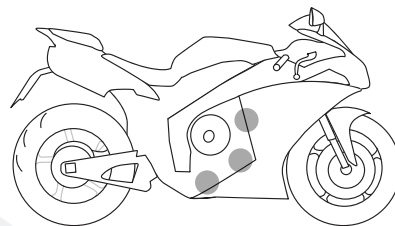

CODICE/CODE	MODELLO/MODEL	COLORE/COLOUR					EURO w/o tax
TTLEI	M6X25	Dn	Si	Rg	Cr	Eb	2,05
TTLEI	M8X15	Dn	Si	Rg	Cr	Eb	2,10
TTLEI	M8X20	Dn	Si	Rg	Cr	Eb	2,20
TTLEI	M8X25	Dn	Si	Rg	Cr	Eb	2,30
TTLEI	M8X30	Dn	Si	Rg	Cr	Eb	2,40
TTLEI	M8X35	Dn	Si	Rg	Cr	Eb	2,50
TTLEI	M8X40	Dn	Si	Rg	Cr	Eb	2,60
TTLEI	M8X45	Dn	Si	Rg	Cr	Eb	2,70
TTLEI	M8X50	Dn	Si	Rg	Cr	Eb	2,80
TSPEI	M4X10	Dn	Si	Rg	Cr	Eb	1,10
TSPEI	M4X15	Dn	Si	Rg	Cr	Eb	1,20
TSPEI	M4X20	Dn	Si	Rg	Cr	Eb	1,30
TSPEI	M5X10	Dn	Si	Rg	Cr	Eb	1,10
TSPEI	M5X15	Dn	Si	Rg	Cr	Eb	1,20
TSPEI	M5X20	Dn	Si	Rg	Cr	Eb	1,30
TSPEI	M5X25	Dn	Si	Rg	Cr	Eb	1,40
TSPEI	M5X30	Dn	Si	Rg	Cr	Eb	1,50
TSPEI	M5X35	Dn	Si	Rg	Cr	Eb	1,60
TSPEI	M5X40	Dn	Si	Rg	Cr	Eb	1,70
TSPEI	M6X10	Dn	Si	Rg	Cr	Eb	1,15
TSPEI	M6X15	Dn	Si	Rg	Cr	Eb	1,20
TSPEI	M6X20	Dn	Si	Rg	Cr	Eb	1,30
TSPEI	M6X25	Dn	Si	Rg	Cr	Eb	1,40
TSPEI	M6X30	Dn	Si	Rg	Cr	Eb	1,50
TSPEI	M6X35	Dn	Si	Rg	Cr	Eb	1,60
TSPEI	M6X40	Dn	Si	Rg	Cr	Eb	1,70
TSPEI	M6X45	Dn	Si	Rg	Cr	Eb	1,80
TSPEI	M6X50	Dn	Si	Rg	Cr	Eb	1,90
TSPEI	M6X55	Dn	Si	Rg	Cr	Eb	2,00
TSPEI	M6X60	Dn	Si	Rg	Cr	Eb	2,10
TSPEI	M6X65	Dn	Si	Rg	Cr	Eb	2,20
TSPEI	M6X70	Dn	Si	Rg	Cr	Eb	2,30

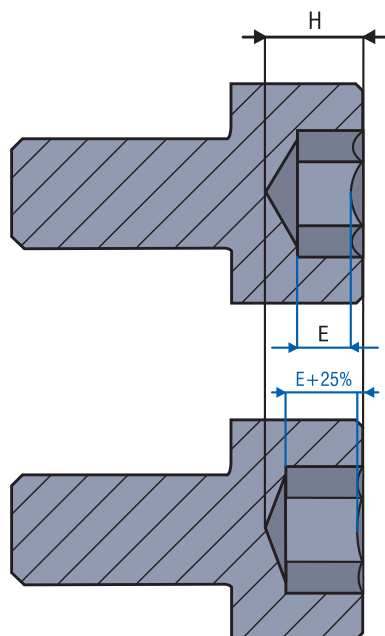

**VITE CONCORRENZA /
COMPETITORS BOLT**

VITE EVOTECH / EVOTECH BOLT
Superficie manovra esagono >25%
Hexagonal hole increased of 25%

**GARANZIA PRODOTTO 5 ANNI
5 YEARS PRODUCT GUARANTEE**

VITERIA IN ERGAL

ERGAL BOLTS

VITI SPECIALI/SPECIAL BOLTS

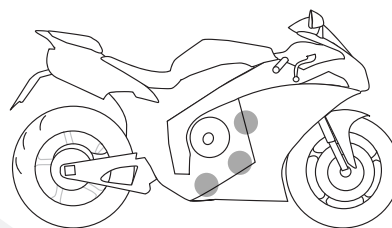

CODICE/CODE	M	LG	DC	LC	DT	COLORE/COLOUR	EURO w/o tax
VS-001	M5	16,5	8,1	5,9	14	Dn Sf Rg Cr Eb	2,30
VS-002	M5	12,5	8,1	2,8	14	Dn Sf Rg Cr Eb	2,30
VS-003	M6	20	8,55	10	18	Dn Sf Rg Cr Eb	2,90
VS-004	M6	12,5	8,2	2,8	14	Dn Sf Rg Cr Eb	2,30
VS-005	M6	16,5	8,15	4,9	14	Dn Sf Rg Cr Eb	2,30
VS-006	M5	11,6	8	2,6	14	Dn Sf Rg Cr Eb	2,30
VS-007	M5	12	7	2	14	Dn Sf Rg Cr Eb	2,30
VS-008	M5	10	7	2	14	Dn Sf Rg Cr Eb	2,20
VS-009	M4	12	/	/	9	Dn Sf Rg Cr Eb	1,60
VS-010	M6	17,4	7,9	8,4	17	Dn Sf Rg Cr Eb	2,30
VS-011	M5	15	7,4	7,5	12	Dn Sf Rg Cr Eb	2,30
VS-016	M8	24,5	9,9	5,5	15	Dn Sf Rg Cr Eb	2,30
VS-017	M6	12,5	10	4,2	15	Dn Sf Rg Cr Eb	2,30
VS-019	M8	33	9,9	11	15	Dn Sf Rg Cr Eb	2,30
VS-021	M4	21,5	4	5,5	10	Dn Sf Rg Cr Eb	1,30
VS-022	M4	7	/	/	10	Dn Sf Rg Cr Eb	1,15
VS-023	M6	20	8,3	9,5	18	Dn Sf Rg Cr Eb	1,15
VS-024	M6	12	/	/	8,5	Dn Sf Rg Cr Eb	2,30
VS-025	M6	11,5	8,2	3,75	14	Dn Sf Rg Cr Eb	2,30
VS-026	M6	15	7,9	6	14	Dn Sf Rg Cr Eb	2,30
VS-027	M6	15	8,9	4	14	Dn Sf Rg Cr Eb	2,30
VS-029	M6	15	9,9	3,5	17	Dn Sf Rg Cr Eb	2,30
VS-030	M6	15	9	2	14	Dn Sf Rg Cr Eb	2,30
VS-031	M6	14	7,9	5,5	14	Dn Sf Rg Cr Eb	2,30
VS-032	M6	21	8,25	13	17	Dn Sf Rg Cr Eb	2,30
VS-033	M6	25,5	8	10,5	24	Dn Sf Rg Cr Eb	2,30
VS-034	M6	19,7	9,9	8,7	17	Dn Sf Rg Cr Eb	2,30
VS-035	M6	11,9	7,9	3,9	16	Dn Sf Rg Cr Eb	2,30
VS-036	M6	18,3	7,8	7,8	15,6	Dn Sf Rg Cr Eb	2,30
VS-037	M6	13	6,9	4,4	14	Dn Sf Rg Cr Eb	2,30
VS-038	M6	15	7,9	6	17	Dn Sf Rg Cr Eb	2,30
VS-039	M6	11	9,9	3,5	17	Dn Sf Rg Cr Eb	2,30
VS-041	M6	14,5	11,9	3,5	17	Dn Sf Rg Cr Eb	2,30
VS-043	M6	19,5	7,5	3,5	14	Dn Sf Rg Cr Eb	2,30
VS-052	M6	15	7,9	3	14	Dn Sf Rg Cr Eb	2,30
VS-053	M6	15	9,85	5	22	Dn Sf Rg Cr Eb	2,30
VS-054	M6	19	7,9	8	14	Dn Sf Rg Cr Eb	2,30
VS-056	M6	14	7,9	3,8	14	Dn Sf Rg Cr Eb	2,30
VS-058	M6	16	8,4	3,5	14	Dn Sf Rg Cr Eb	2,30
VS-060	M5	10	8,9	3	14	Dn Sf Rg Cr Eb	2,30
VS-061	M6	15	8,9	5	14	Dn Sf Rg Cr Eb	2,30
VS-062	M5	15	7	2,5	11,5	Dn Sf Rg Cr Eb	2,30
VS-063	M5	20,5	7	13,5	12	Dn Sf Rg Cr Eb	2,30
VS-064	M5	20,5	6,9	2,5	12	Dn Sf Rg Cr Eb	2,30
VS-065	M6	11	8,2	4	14	Dn Sf Rg Cr Eb	2,30
VS-066	M6	15	9,8	5,5	22	Dn Sf Rg Cr Eb	2,30
VS-069	M6	25,5	8	13,5	17	Dn Sf Rg Cr Eb	2,30
VS-071	M6	21	10	8	17	Dn Sf Rg Cr Eb	2,30
VS-075	M6	16,5	8,2	5	12	Dn Sf Rg Cr Eb	2,30
VS-077	M5	17	8,2	5,8	14	Dn Sf Rg Cr Eb	2,30
VS-078	M6	20	8,7	9,2	14	Dn Sf Rg Cr Eb	2,30
VS-091	M5	8	7,9	2	13	Dn Sf Rg Cr Eb	2,30

M	Diametro filetto/Thread diameter
LG	Lunghezza gambo/Shank length
DC	Diametro cilindro/Cylinder diameter
LC	Lunghezza cilindro/Cylinder length
DT	Diametro testa/Head diameter

COOL STRIPES

ADESIVI PER CERCHI

WHEEL STICKERS

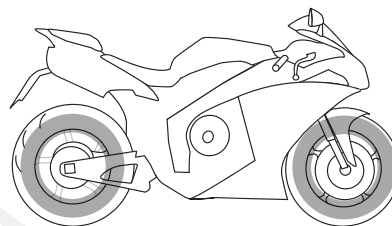

I nuovissimi adesivi per cerchi "Cool Stripes" daranno un ulteriore tocco di stile alla vostra special. Evotech ancora una volta porta innovazione e trova un nuovo modo per arricchire di personalità la vostra motocicletta. Gli adesivi "Cool Stripes" sono già pre-sagomati sulla forma dei cerchi da 14 a 17". In questa maniera sarà facile attaccarli al cerchio, evitando il fastidioso effetto "poligono" che spesso si vede con le classiche strisce adesive. Il colore di fondo è sempre nero, mentre i loghi sono disponibili in vari colori per adeguarsi alla carrozzeria della vostra moto. Dai un tocco di colore e di stile alla tua moto! Con Evotech!

Adhesive stripes kit preformed to personalize in a completely new way your motorbike's y wheels! "Cool stripes" stickers for 14-17 rims. In order to take heed of the design this time Evotech not only gives you the common mono-color stripes but it also offers you a circle shaped sticker, which is therefore much easier to apply. The stripes have a coloured writing on a black background! Give color and style to your motorbike ... Evotech!



MARCA/BRAND	DESCRIZIONE/DESCRIPTION	CODICE/CODE	COLORE/COLOUR	EURO w/o tax
EVOTECH	KIT PER 1 MOTO / FOR ONE BIKE	STRIP-01 / Cr	ROSSO / RED	18,00
	KIT PER 1 MOTO / FOR ONE BIKE	STRIP-01 / Eb	BLU / BLUE	18,00
	KIT PER 1 MOTO / FOR ONE BIKE	STRIP-01 / Wh	BIANCO / WHITE	18,00
	KIT PER 1 MOTO / FOR ONE BIKE	STRIP-01 / Gr	VERDE / GREEN	18,00
	KIT PER 1 MOTO / FOR ONE BIKE	STRIP-01 / Ye	GIALLO / YELLOW	18,00
	KIT PER 1 MOTO / FOR ONE BIKE	STRIP-01 / Or	ARANCIO / ORANGE	18,00



MARCA/BRAND	DESCRIZIONE/DESCRIPTION	CODICE/CODE	COLORE/COLOUR	EURO w/o tax
T-MAX	KIT PER 1 MOTO / FOR ONE BIKE	STRIP-02/Cr	ROSSO / RED	18,00
	KIT PER 1 MOTO / FOR ONE BIKE	STRIP-02 / Eb	BLU / BLUE	18,00
	KIT PER 1 MOTO / FOR ONE BIKE	STRIP-02 / Wh	BIANCO / WHITE	18,00
	KIT PER 1 MOTO / FOR ONE BIKE	STRIP-02 / Ye	GIALLO / YELLOW	18,00

ACCESSORI RACING

SGANCI RAPIDI / QUICK FUEL COUPLING

Questo pratico accessorio consente di rimuovere agevolmente il serbatoio dalla moto evitando qualsiasi perdita di carburante. Basterà semplicemente tagliare i vari tubi benzina e/o sfiati e collegarli alle due estremità dello sgancio rapido. Una volta installati sarà sufficiente la pressione di un dito per sganciare i tubi senza far fuoriuscire il carburante. Realizzati in Acetal (speciale resina termoplastica) sono robusti, resistenti al calore e possono essere utilizzati anche su impianti ad iniezione (max pressione 83 bar).

This simple but brilliant accessory allows to quicken and makes easier and comfortable the removal of the tank. Indispensable on the races, very useful on every motorbike /mini bike, allows to tear out the fuel pipes by simply pressing of a button. It has a double valve system which prevents the leak of gasoline. Realized in a special thermoplastic resin (Acetal) they are extremely light, heavy-duty, hydrocarbon-proof and resist even to high pressure (83 bar).

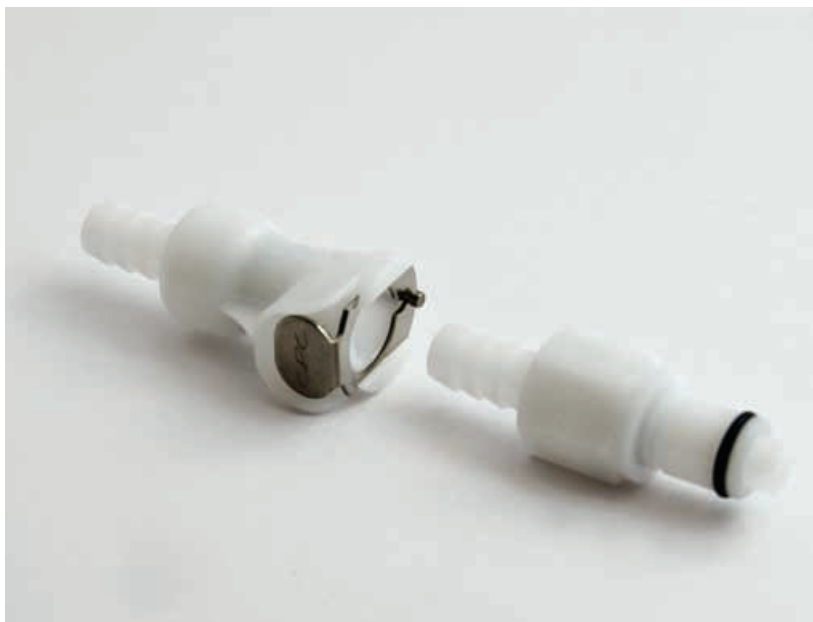

DISPONIBILI PER TUBI BENZINA CON DIAMETRO INTERNO 8 mm e 6,4 mm
AVAILABLE FOR PETROL TUBES WITH 8mm AND 6,4mm DIAMETER

CODICE/CODE	DESCRIZIONE/DESCRIPTION	EURO w/o tax
EV-BSG	SGANCIO RAPIDO BENZINA 8mm/8mm QUIK FUEL COUPLING	28,00
EV-BSP	SGANCIO RAPIDO BENZINA 6,4mm/6,4mm QUICK FUEL COUPLING	32,00

RECUPERO SFIATI RACING / RECOVERING TANK

Serbatoio di recupero per sfiati acqua, olio o benzina. Ideale per sostituire gli ingombranti serbatoi di recupero originali. Il kit è composto da:

- una bottiglia in plastica semi-trasparente con tappo filettato (predisposto per filo di sicurezza)
- un supporto in alluminio anodizzato nero, asolato per facilitare il fissaggio dove preferite
- un o-ring per fissare la bottiglia sul supporto.

Recovering tank for water, oil and fuel vents. This is the perfect solution for replacing the original recovering tank.

This kit includes:

- a semi-transparent plastic bottle with threaded caps (suitable for safety wire).
- one aluminum support laser cut, satinized, black anodized and laser branded.
- one o-ring to fix the bottle on the support

It is ideal also for Supermotard motorbikes where it can be used to recover the various gas, oil and water leaks.



PB-01	RECUPERO SFIATI RACING/RACING RECOVERING TANK 500 ml.	28,00
PB-02	RECUPERO SFIATI RACING/RACING RECOVERING TANK 250 ml.	25,00

ACCESSORI RACING

SGANCI RAPIDI 1/4 DI GIRO / TURN FAIRING FASTENERS

Permettono di smontare e rimontare velocemente le carene e altri pannelli in genere, senza bisogno di attrezzi! (1 perno con anello a scelta, 1 rondella teflon, 1 ricettacolo a scelta).

They enable you to assemble and disassemble the fairing and others boards without any tools! (1 ring head, 1 teflon spacer, 1 slip or rivet receptable)



CODICE/CODE	DIAM. X LUNGH./DIAMETER	RICETTACOLO /RECEPTABLE	EURO w/o tax
SG-12-SLIP	6 x 12mm	a clip	5,00
SG-12-RIV	6 x 12mm	a rivettare	5,00
SG-412-SLIP	4 x 12mm	a clip	6,00
SG-412-RIV	4 x 12mm	a rivettare	6,00
SG-17-SLIP	6 x 17mm	a clip	5,00
SG-17-RIV	6 x 17mm	a rivettare	5,00

CODICE/CODE	DESCRIZIONE /DESCRIPTION	EURO w/ o tax
SG-12	PERNO CON ANELLO/RING HEAD 6 x 12mm	3,50
SG-17	PERNO CON ANELLO/RING HEAD 6 x 17mm	3,50
SGB-12	PERNO SENZA ANELLO/NO RING HEAD 6 x 12mm	3,50
SGB-17	PERNO SENZA ANELLO/NO RING HEAD 6 x 17mm	3,50
326-100-040	RONDELLA TEFLON x SGANCI 6mm/TEFLON SPACER	0,20
336-300-190	RICETTACOLO A CLIP 6mm/SLIP RECEPTABLE	2,30
336-400-190	RICETTACOLO A RIVETTARE 6mm/RIVET RECEPTABLE	2,30
SG-412	PERNO CON ANELLO/RING HEAD 4 x 12mm	3,80
324-100-040	RONDELLA TEFLON x SGANCI 4mm/TEFLON SPACER	0,20
334-300-190	RICETTACOLO A CLIP 4mm/SLIP RECEPTABLE	2,50
334-400-190	RICETTACOLO A RIVETTARE 4mm/RIVET RECEPTABLE	2,50

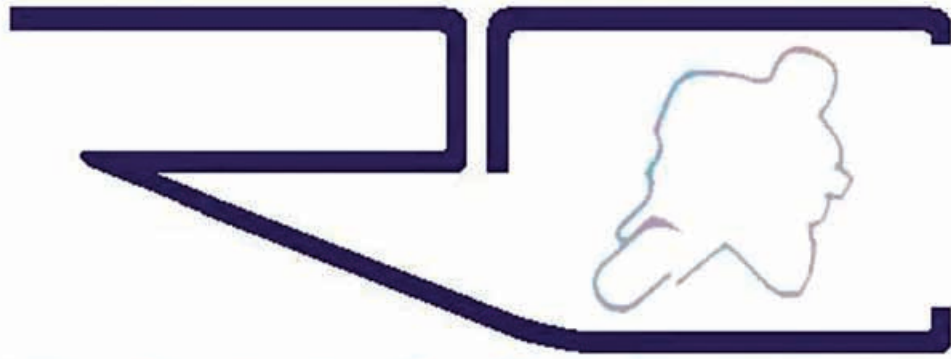

ROSSOCARENA
racing

**Carenature in fibra di vetro
e fibra di carbonio**

**Fiberglass and carbonfibre
fairings**

www.rossocarena.com - info@rossocarena.com

Evotech non distribuisce tale prodotto



EVOTECH

\ INNOVIAMO PER VOI \

La dimostrazione della posizione all'avanguardia di EVOTECH è rappresentata dai numerosi progetti estremamente innovativi, tutti in fase avanzata di prototipazione, nati dalla collaborazione con numerosi partner tra cui Centro Ricerche Fiat. Questi progetti in fase di sviluppo vengono intrapresi dal brand EVOTECH H2 e abbracciano il settore della mobilità a zero emissioni legato alle energie rinnovabili.

The Evotech advanced technology is showed in many new and innovative projects concerning the zero-emissions mobility and the renewable energies resources. These advanced projects originate from the collaboration with various partners, such as the Fiat Center of Research.



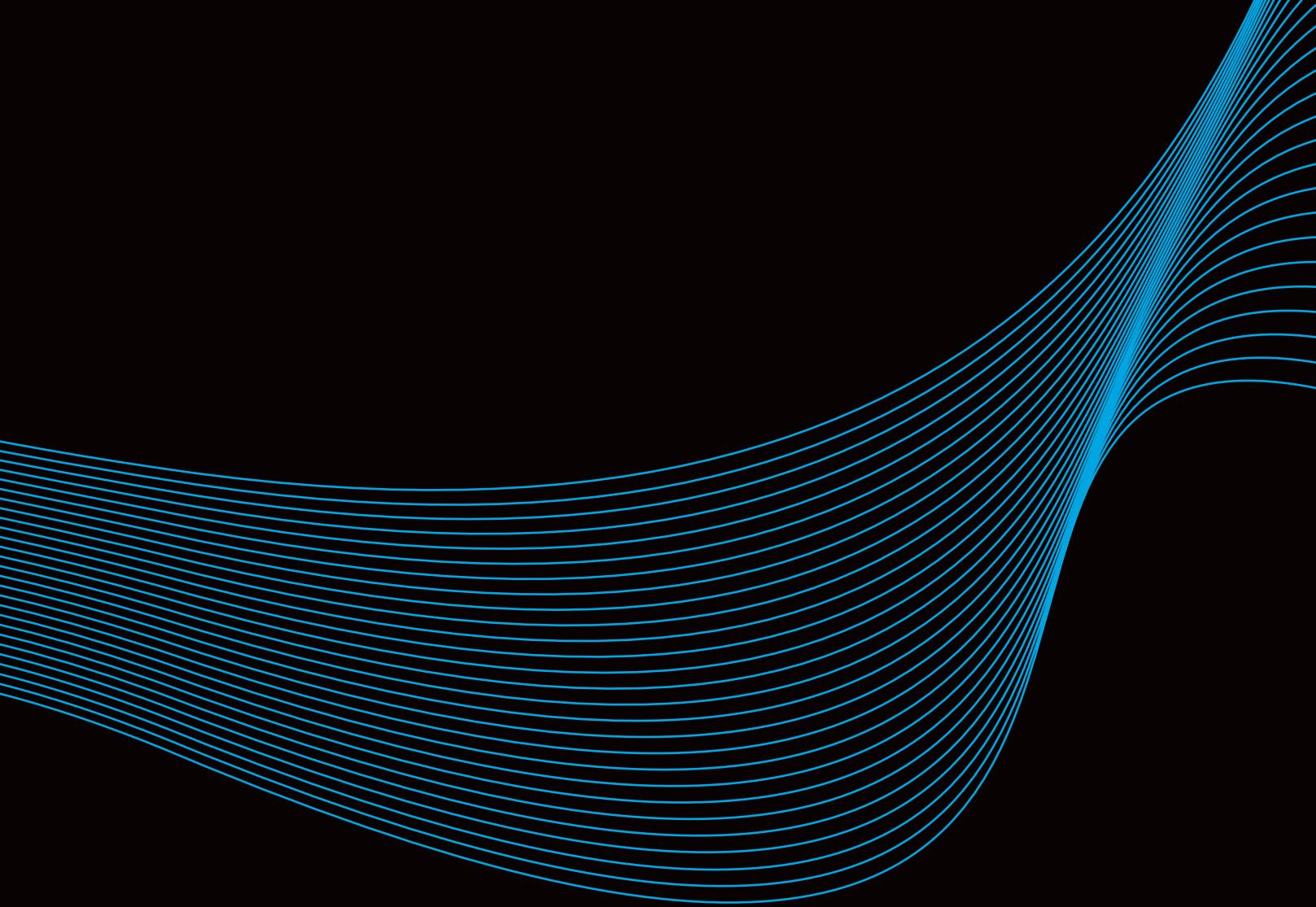

Zero emissioni
Zero emission

HYDR **OGEN**



Mobilità sostenibile
Sustainable mobility



Condizioni generali di vendita

General sales conditions

ORDINI

Gli ordini per il materiale standard e speciale sono impegnativi per il Cliente. Una volta avviata la produzione non si accettano annullamenti o riduzioni dell'ordine, salvo il risarcimento da parte del Cliente dei costi del materiale e di lavorazione sostenuti fino al momento della sospensione.

PREZZI

I prezzi applicati sono quelli in vigore alla data dell'ordine. Qualora nel corso della fornitura si verificassero sostanziali aumenti del costo del materiale o altri costi di produzione, per cause non imputabili a EVOTECH S.r.l., sarà facoltà di EVOTECH S.r.l. stessa adeguare i prezzi ed il costo. I prezzi indicati nel presente listino si intendono Iva esclusa.

TEMPI DI CONSEGNA

Gli ordini sono evasi dallo stock EVOTECH. I tempi di consegna massimi sono di 15 giorni lavorativi dal ricevimento dell'ordine. Questi tempi di consegna non sono validi in periodi come Agosto, Natale e Pasqua. In caso di slittamento dei termini di consegna, EVOTECH S.r.l. provvederà a comunicare al Cliente le variazioni.

CONSEGNA

La merce ordinata è consegnata franco fabbrica. Sarà a cura del Cliente informare la EVOTECH S.r.l. circa il suo spedizioniere abituale al momento dell'ordine. Le spese di spedizione sono a carico del Cliente. Nel caso in cui il Cliente non abbia esigenze circa lo spedizioniere abituale, EVOTECH S.r.l. provvederà a consegnare la merce tramite proprio spedizioniere abituale, addebitando al Cliente la totalità delle spese di spedizione. Tali spese comprendono anche le spese di imballaggio necessarie al trasporto.

PAGAMENTI

Saranno riconosciuti validi solo i pagamenti nei modi e nei tempi pattuiti. Trascorso il termine di pagamento, EVOTECH S.r.l. si riserva il diritto di sospendere le consegne di ordini in corso e/o di pretendere il pagamento anticipato nel caso di eventuali ordini successivi, senza riconoscere al committente indennizzi di sorta o risarcimenti. Qualsiasi contestazione riguardante i materiali in corso di fabbricazione o già in possesso del Cliente non libera quest'ultimo dall'effettuare il pagamento alla scadenza stabilita.

ORDERS

All orders are binding once production has started. Any cancellation or reduction of an order will not be accepted, unless the customer pays an indemnity for any material and labor costs incurred by Evotech.

PRICES

Prices are in force from the date of order. Prices are in force from the date of order. If material and labor costs increase during the supply of goods, due to causes beyond Evotech's control, Evotech will revise their prices. All prices in this catalogue don't include VAT.

DELIVERY TIME

Orders will be dispatched from Evotech in 15 working days.

DELIVERY

Goods are dispatched ex factory (at buyer's risk). The Buyer has to inform Evotech of his usual forwarding agent. If the customer does not have a particular forwarding agent then Evotech will deliver the goods through their own courier, all expenses will be charged to the customer. These charges will also include packing expenses.

PAYMENT

Payment must be made according to the agreed way and within the agreed time scale. If payment becomes overdue, Evotech has the right to stop the delivery and to claim a payment in advance without paying any compensation to the Buyer. Any objection about materials in progress or in the customer's hands does not relieve the customer of the due payment.

GARANZIA

EVOTECH S.r.l. garantisce i prodotti contro difetti di fabbricazione per due anni dalla data di acquisto. In caso di prodotti difettosi acquistati direttamente da EVOTECH S.r.l. si raccomanda al Cliente di comunicare preventivamente il difetto ad EVOTECH S.r.l. e di inviare a proprie spese il prodotto difettoso, accompagnato da prova di acquisto e descrizione dei difetti in forma scritta. I resi debbono essere autorizzati da EVOTECH S.r.l. mediante fax di conferma. EVOTECH S.r.l. si riserva di analizzare i prodotti resi per identificarne le cause di reso. Per il materiale danneggiato da montaggio e/o uso scorretto del prodotto non verranno riconosciute garanzie di alcuna sorta. In caso di acquisto effettuato presso altro rivenditore si raccomanda al Cliente di contattare il rivenditore stesso consegnandogli il prodotto difettoso e la prova di acquisto. Garanzia sui prodotti 5 anni.

PROPRIETÀ

Tutta la merce spedita rimane di proprietà EVOTECH S.r.l. fino al saldo completo delle fatture.

PRIVACY

EVOTECH S.r.l. si impegna ad utilizzare i dati sensibili del Cliente ai sensi dell'art. 13, D.Lgs 30/06/2003 n. 196. L'archiviazione è in forma cartacea ed informatica. Al Cliente è consentito in ogni momento la variazione dei propri dati tramite comunicazione scritta.

FORO COMPETENTE

Qualsiasi controversia inerente ai rapporti commerciali con EVOTECH S.r.l., sarà di competenza del Tribunale di Trento.

VALIDITÀ

Il presente catalogo è stato dato alle stampe il 1 febbraio 2010. Ogni condizione e prezzo in esso elencato è valido a partire dal 1 febbraio 2010 fino ad ulteriore revisione.

WARRANTY

Evotech guarantees all goods against any manufacturing defects for up to 2 years, starting from the purchase date. In case of faulty items, which have been bought directly from Evotech, we recommend you contact Evotech immediately. The faulty product must be returned, at the Buyers costs, together with a proof of purchase and a written description of the defect. Returned items have to be authorized by Evotech by fax. Evotech has the right to analyze the returned items in order to check the cause of the damage. A guarantee will not be valid if items are damaged because of incorrect assembly and/or incorrect use. If the product has been purchased from a retailer, Evotech recommends you contact them directly advising them of the fault and including a proof of purchase.

OWNERSHIP

Evotech owns all dispatched goods until the invoice has been settled in full.

PRIVACY

Evotech will use the customer's details according to the article no.13, D.Lgs 30/60/2003 n.196. The data will be kept on written and digital files. The customer can modify his details at any time by written notification.

JURISDICTION

Any trade debate will be resolved by the Trento's tribunal.

VALIDITY

This catalogue was printed on 1st February 2010. Terms and prices are valid from 1st February 2010 until further notice.

Note legali

Il marchi APRILIA®, BMW®, CAGIVA®, DUCATI®, HONDA, KAWASAKI®, MOTO GUZZI®, MV AGUSTA®, SUZUKI®, TRIUMPH®, YAMAHA® non vengono assolutamente riportati sui prodotti di produzione Evotech. Tuttavia tali marchi vengono menzionati nei cataloghi e sul sito www.evotech-rc.it esclusivamente per riferire il prodotto al modello del motoveicolo.

La produzione EVOTECH è in continua evoluzione e per questo ci risulta impossibile mantenere aggiornato il nostro catalogo.
Vi proponiamo quindi di frequentare mensilmente il nostro sito internet:
www.evotech-rc.it
troverete anche tutte le istruzioni e consigli per il montaggio di ogni prodotto, foto di prodotti montati sulle motociclette per aiutarvi nella vendita ed una serie di applicazioni che non potevamo inserire a catalogo per motivi di spazio.

Evotech Srl has no connection with APRILIA®, BMW®, CAGIVA®, DUCATI®, HONDA, KAWASAKI®, MOTO GUZZI®, MV AGUSTA®, SUZUKI®, TRIUMPH®, YAMAHA® and/or their dealers. All items with trade mark names for motorcyrclcs identification are to be intended only as a reference for the use in our catalogue and on our website www.evotech-rc.it

Evotech's production continually evolves, this makes it impossible to maintain an up to date catalogue. For this reason we recommend you regularly visit our web site:
www.evotech-rc.it

where you can find fitting instructions and advice for our products, there are also images of our products fitted to motorbikes. The web site will also show extra applications which are not in this catalogue due to space reasons.

Se gradite, registratevi al nostro servizio Newsletter, in questo modo sarete sempre al corrente delle ultime novità e potrete approfittare in maniera tempestiva di tutte le promozioni speciali riservate ai nostri rivenditori ufficiali

If you wish, you can register on our website for our newsletter, this will keep you informed of new products and any special promotions.

EVOTECH S.r.l. declina ogni responsabilità per eventuali usi impropri degli articoli. Si declina inoltre ogni responsabilità per danni fisici, morali o materiali di qualsiasi entità dovuti a uso, applicazioni o montaggio scorretti. Gli articoli commercializzati dalla EVOTECH s.r.l. non sono omologati e come tali non possono venire usati al di fuori di aree private, circuiti e manifestazioni. Alcuni prodotti non sono sottoposti alle norme riguardanti la circolazione sulle strade pubbliche, consultare le leggi in vigore a riguardo.

©2010 All rights reserved by Evotech S.r.l. E' severamente vietata la riproduzione di tutte le immagini riportate sul presente catalogo.

EVOTECH PRODUCES FOR



EVOTECH S.R.L.

Via da Borgo, 14 - 38059 VILLA AGNEDO (TN)
Tel. +39 0461 780184 - Fax +39 0461 782707

www.evotech-rc.it / e-mail: info@evotech-rc.it

SPAIN

www.evotech-rc.es / e-mail: info@evotech-rc.es